

Position detection and monitoring with system

Position switch family PS



Introduction



Philip Schmersal, Executive Director of the Schmersal Group, and Michael Mandel, Managing Director of K.A. Schmersal GmbH & Co. KG

Schmersal position switch – the continuation of a success story!

Position switches at Schmersal have a long tradition and belong to the company's core areas of expertise. This tradition is now being continued with the new position switch family PS.

For automation, safety applications and elevator technology – the new series is suitable for a broad range of applications across all individual disciplines of machine and plant construction.

The complete portfolio of the PS-series, whose elements can be combined in numerous ways and used like a building block system, stands for secure and reliable position detection. The modular design with consistent components enables efficient and flexible solutions.

This brochure provides an overview of the diverse areas of application of the new position switch family PS.

Content

Introduction	Page 02
Content	Page 03
1. Description	Page 04
2. Order information complete device or modular construction kit	Page 06
2.1 Ordering code	Page 07
3. Standardised construction forms, unusual features	Page 08
4. Overview of the series	Page 10
5. Actuator heads	
5.1 PS116 / PS2xx – Actuator heads	Page 12
5.2 PS3xx – Actuator heads	Page 16
6. Preferred types and ordering details	
6.1 PS116	Page 20
6.2 PS2xx	Page 22
6.3 PS3xx	Page 24
Addresses	Page 26

Position switches

Description

System universally deployable series

Recording and monitoring, from extraordinarily compact to very robust.

With these properties, the new position switches are aimed at a wide variety of applications across all disciplines of mechanical engineering and plant manufacturing as well as elevator technology.

The advantages of the new position switch series at a glance:

- Reliable position detection
- Highly versatile
- Robust and reliable
- Can be combined in numerous ways thanks to modular design

Area of application

Type 1 position switches according to ISO 14119 are for determining the position and monitoring of movable components on machines and for protective equipment that can be moved laterally or is rotatable. This allows them to be used in all industrial environments.

The protection classes IP66 an IP67 form the requirements for the use of position switches in adverse ambient conditions.

Design and way of functioning

All position switches are equipped with positive opening normally-closed contacts in accordance with IEC 60947-5-1 and are available with snap action and also slow action. In conjunction with an appropriate safety controller, a single position switch can be used up to PL d. Using two position switches PL e can be achieved according to ISO 13849-1.

Flexible solutions

Switching elements with up to 3 contacts

Switching elements with three contacts ensures a redundant switch-off with additional signalling contact. All switching elements of the diverse contact combinations are equipped with galvanically separated contacts with positive break NC contacts.

Latching function

To save the switching state, versions are available with snap action and an optional latching function where the mounting element must be manually reset to the starting condition.

Modular diversity

The modular design with consistent components across all series reduces the number of different versions, lowers the effort required for storage and increases availability.



Actuator elements and lever

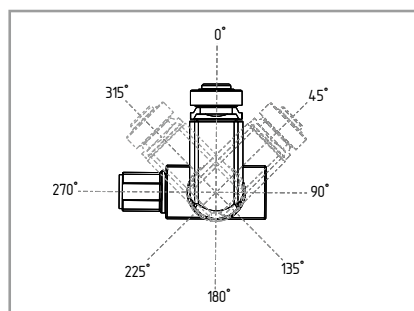

Adjustable actuator elements

All actuator elements can be rotated in 45° steps and can be quickly replaced and implemented due to the simple mounting design.

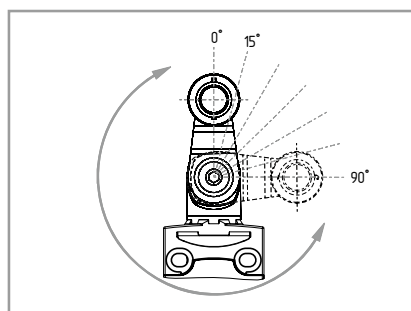

Adjustable lever

Roller lever can be set in 15° steps.

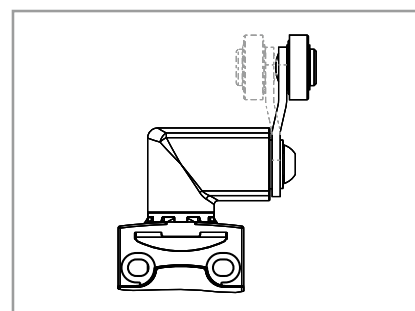

Rotatable lever

For versions with a rotatable roller lever, the lever can be fitted so that the roller is on the inside.

Position switches

Order information complete device or modular construction kit

All position switches of the PS116, PS2xx and PS3xx series can be obtained either as a complete device or a modular construction kit. The complete device with actuating element S200 serves as a basic switch in the construction kit system. The following ordering example can therefore be transferred to all of the series listed.

Ordering example

Position switch PS116, snap action 1 NO contact / 1 NC contact, roller lever, M12 connector on right

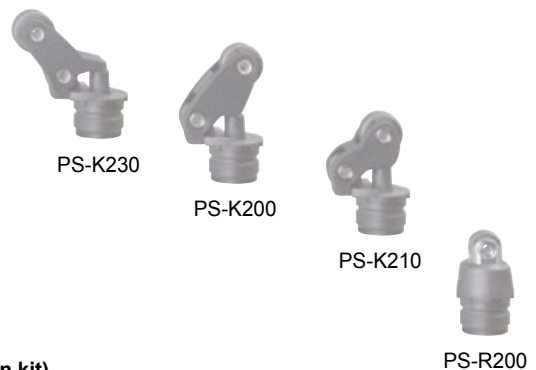

Complete device

Modular selection (construction kit) to be ordered separately



PS116-Z11-STR-H200



Basic switch:
PS116-Z11-STR-S200



Actuator head:



For assembly of the modular selection, the enclosure of the thrust pin included in the basic switch must be removed and replaced with the roller lever PS-H200.



PS-J200

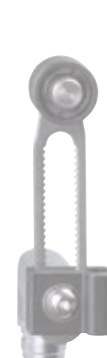

PS-N200



PS-K250

Ordering code

PSxxx-Z11-L200-S200

Switching elements (others on request)

Z11	Snap action 1 NO contact / 1 NC contact
Z12	Snap action 1 NO contact / 2 NC contacts
Z11R	Snap action 1 NO contact / 1 NC contact with latching (not for PS3xx)
T11	Slow action 1 NO contacts / 1 NC contact
T12	Slow action 1 NO contacts / 2 NC contact
T03	Slow action 3 NC contacts
T11UE	Slow action 1 NO contact / 1 NC contact with overlapping contacts
T02H	Slow action 2 NC contacts with staggered contacts

Connection

	Cable entry M20, screw connection
ST	Connector plug M12, bottom
STR	Connector plug M12, right
L200	Pre-wired cable bottom, 2 m (PS116 only)
LR200	Pre-wired cable right, 2 m (PS116 only)

Actuator elements (more on request)

PS116 and PS2xx series

S200	Plunger
R200	Roller plunger, roller Ø 9.5 mm
K200	Offset roller lever, roller Ø 12 mm
K210	Offset roller lever, roller Ø 14 mm
K230	Angle roller lever, roller Ø 14 mm
K240	Angle roller lever, roller Ø 22 mm
K250	Angle roller lever, roller Ø 22 mm
H200	Roller lever, roller Ø 16 mm, length 24 mm
N200	Roller lever, roll Ø 20 mm, can be adjusted in 2 mm increments (24 ... 66 mm)
J200	Rod lever with plastic rod Ø 6 mm, length 200 mm

PS3xx series

S300	Plunger
R300	Roller plunger, roller Ø 17.2 mm
K360	Angle roller lever, roller Ø 20 mm
K370	Offset roller lever, roller Ø 20 mm
H300	Offset roller lever, roller Ø 25 mm
N300	Roller lever, roll Ø 20 mm, can be adjusted in 2 mm increments (24 ... 66 mm)
J300	Rod lever, rod Ø 6 mm, length 200 mm

PS2xx / PS3xx

Standardised construction forms, extraordinary features

Folding
latching cover



All plastic versions are fitted with a folding and captive latching cover. The cover can be opened with the aid of a head screwdriver and needs no tools to be closed.

Reduced
assembly times

The 45° rotated connection terminals of all switch elements reduce the assembly time considerably.



Actuator element replace and turn

All actuator elements can be rotated in 45° steps and can be quickly replaced and implemented due to the simple mounting design. This means that adaptation to the prescribed actuating direction is possible at any time.

PS116



1. Release locking plate
(head screwdriver or
accessory tool ACC-PS116-1)

2. Remove or turn existing
actuating element

3. Position of new actuator
element

4. Secure locking
plate

The symmetrical layout of the enclosure means that it can be used for left-hand and right-hand versions of the same switch. This applies to both the cable and the connector design.

PS2xx / PS3xx



1. Release locking plate
(head screwdriver)

2. Remove or turn existing
actuating element

3. Position of new actuator
element

4. Secure locking plate

Position switches

Overview of the series



■ PS116



■ PS215



■ PS216

Key Features

- | | | |
|---|---|--|
| <ul style="list-style-type: none"> • Symmetrical casing • Compact design • Fitted (cable / M12 connector) • Complete device or modular construction kit • Design to EN 50047 | <ul style="list-style-type: none"> • Simplified connection (connection terminals rotated by 45°) • Robust design • Fitted (M12 connector) • Complete device or modular construction kit • Design to EN 50047 | <ul style="list-style-type: none"> • Simplified connection (connection terminals rotated by 45°) • Folding latching cover • Fitted (M12 connector) • Complete device / modular selection • Design to EN 50047 |
|---|---|--|

Technical features

Electrical characteristics			
Switching system	Snap-/slow action	Snap-/slow action	Snap-/slow action
Latching variant	■	■	■
Max. number of contacts	3	3	3
Max. switching capacity U/I	230 VAC / 3 A; 24 VDC / 1.5 A	230 VAC / 3 A; 24 VDC / 3 A	230 VAC / 3 A; 24 VDC / 3 A
Mechanical data			
Housing material	Metal / thermoplastic enclosure	Metal enclosure, painted	Thermoplastic enclosure
Connection	Cable 4/6 pole M12 connector 4/6 pole	1 x M20 M12 connector 5/8 pole	1 x M20 M12 connector 4/8 pole
Cable section ³⁾	4/6 x 0.5 mm ²	max. 1.5 mm ² (incl. conductor ferrules)	max. 1.5 mm ² (incl. conductor ferrules)
Dimensions (W x H x D)	31 x 52 x 16.6 mm	31 x 66 x 33 mm	31 x 66 x 33 mm
Ambient conditions			
Ambient temperature	-30 °C ... +80 °C	-30 °C ... +80 °C	-30 °C ... +80 °C
Protection class	IP66, IP67	IP66, IP67	IP66, IP67
Actuator heads	see page 12	see page 12	see page 12

Safety classification

Standards	ISO 13849-1	ISO 13849-1	ISO 13849-1
B _{10D} NC contact	20,000,000	20,000,000	20,000,000
Certificates		 under preparation:	 under preparation:



To get detailed information about the products and certificates, visit www.schmersal.net.



■ PS226



■ PS315



■ PS316

- | | | |
|--|---|--|
| <ul style="list-style-type: none"> • Simplified connection (connection terminals rotated by 45°) • Folding latching cover • Fitted (M12 connector) • Complete device or modular construction kit • Design to EN 50047 | <ul style="list-style-type: none"> • Simplified connection (connection terminals rotated by 45°) • Robust design • Fitted (M12 connector) • Complete device or modular construction kit • Design to EN 50041 | <ul style="list-style-type: none"> • Simplified connection (connection terminals rotated by 45°) • Folding latching cover • Fitted (M12 connector) • Complete device or modular construction kit • Design to EN 50041 |
|--|---|--|

Snap-/slow action	Snap-/slow action	Snap-/slow action
■	–	–
3	3	3
230 VAC / 3 A; 24 VDC / 3 A	230 VAC / 3 A; 24 VDC / 3 A	230 VAC / 3 A; 24 VDC / 3 A
Thermoplastic enclosure	Metal enclosure, painted	Thermoplastic enclosure
2 x M20 M12 connector 4/8 pole	1 x M20 M12 connector 5/8 pole	1 x M20 M12 connector 4/8 pole
max. 1.5 mm ² (incl. conductor ferrules) 59 x 56.2 x 33 mm	max. 1.5 mm ² (incl. conductor ferrules) 40 x 77.7 x 37.2 mm	max. 1.5 mm ² (incl. conductor ferrules) 40 x 77.7 x 37.2 mm
–30 °C ... +80 °C	–30 °C ... +80 °C	–30 °C ... +80 °C
IP66, IP67	IP66, IP67	IP66, IP67
see page 12	see page 16	see page 16

ISO 13849-1 20,000,000	ISO 13849-1 20,000,000	ISO 13849-1 20,000,000
under preparation: 	under preparation: 	under preparation:

Position switches

PS116 / PS2xx – Actuator heads



Plunger S200

Roller plunger R200

Actuator heads

Actuator description	Thermoplastic plunger Actuator type B according to EN 50047	Thermoplastic roller plunger Actuator type C according to EN 50047
Positive break force	> 40 N	> 40 N
Actuating speed	min. 10 mm/min, max. 0.5 m/s	min. 10 mm/min, max. 0.5 m/s
Snap action		
Slow action	min. 60 mm/min, max. 0.5 m/s	min. 60 mm/min, max. 0.5 m/s
Positioning the lever	-	-

Ordering data modular construction kit

Type designation	PS-S200	PS-R200
Ordering code	103010968	103010967

Switch travel diagrams

Snap action	Per NO contact / per NC contact		
Slow action	Per NO contact / per NC contact		
	1 NO / 1 NC with overlapping		
	2 NC with staggered contacts		

Contact closed

Contact open

Positive break travel / angle



Offset roller lever K200

Offset roller lever K210

Angle roller lever K230

Thermoplastic offset roller lever
Actuator type E according to EN 50047

Thermoplastic offset roller lever

Thermoplastic angle roller lever

> 40 N

min. 10 mm/min,
max. 1 m/s

min. 60 mm/min,
max. 1 m/s

-

> 40 N

min. 10 mm/min,
max. 1 m/s

min. 60 mm/min,
max. 1 m/s

-

> 40 N

min. 10 mm/min,
max. 1 m/s

min. 60 mm/min,
max. 1 m/s

-

PS-K200

103010961

PS-K210

103010962

PS-K230

103010963

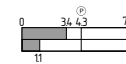
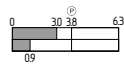
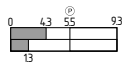
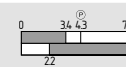
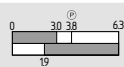
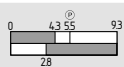
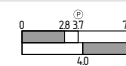
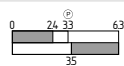
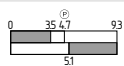
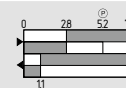
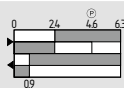
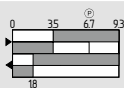

Position switches

PS116 / PS2xx – Actuator heads



Angle roller lever K240

Angle roller lever K250

Actuator heads

Actuator description	Thermoplastic angle roller lever	Thermoplastic angle roller lever
Positive break force	> 40 N	> 40 N
Actuating speed	min. 10 mm/min, max. 1 m/s	min. 10 mm/min, max. 1 m/s
Snap action		
Slow action	min. 60 mm/min, max. 1 m/s	min. 60 mm/min, max. 1 m/s
Positioning the lever	-	-

Ordering data modular construction kit

Type designation	PS-K240	PS-K250
Ordering code	103010964	103010965

Switch travel diagrams

Snap action	Per NO contact / per NC contact		
Slow action	Per NO contact / per NC contact		
	1 NO / 1 NC with overlapping		
	2 NC with staggered contacts		

■ Contact closed

□ Contact open

Ⓟ Positive break travel / angle



Roller lever H200



Roller lever N200



Roller lever J200

Metal lever with plastic roller
Actuator type A according to EN 50047

Length adjustable metal lever
with plastic roller
adjustable in 2 mm increments

Plastic rod, 200 mm
Can only be used for positioning tasks

> 40 N

min. 10 mm/min,
max. 1 m/s

min 60 mm/min,
max. 1 m/s

adjustable in 15° steps

> 40 N

min. 10 mm/min,
max. 1 m/s

min. 60 mm/min,
max. 1 m/s

adjustable in 15° steps

> 40 N

min. 10 mm/min,
max. 1 m/s

min 60 mm/min,
max. 1 m/s

adjustable in 15° steps

PS-H200

103010948

PS-N200

103010966

PS-J200

103010951

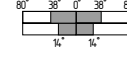
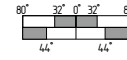
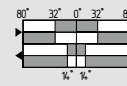
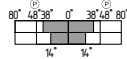
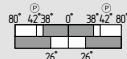
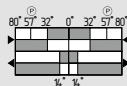
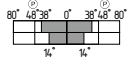
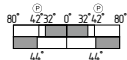
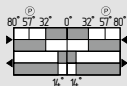

Position switches

PS3xx – Actuator heads



Plunger S300

Roller plunger R300

Actuator heads

Actuator description	Thermoplastic plunger Actuator type B according to EN 50041	Thermoplastic roller plunger Actuator type C according to EN 50041
Positive break force	> 50 N	> 50 N
Actuating speed	min. 10 mm/min, max. 0.5 m/s	min. 10 mm/min, max. 0.5 m/s
Snap action		
Slow action	min. 60 mm/min, max. 0.5 m/s	min. 60 mm/min, max. 0.5 m/s
Positioning the lever	-	-

Ordering data modular construction kit

Type designation	PS-S300	PS-R300
Ordering code	103015397	103015398

Switch travel diagrams

Snap action	Per NO contact / per NC contact		
Slow action	Per NO contact / per NC contact		
	1 NO / 1 NC with overlapping		
	2 NC with staggered contacts		

Contact closed

Contact open

Positive break travel / angle



Angle roller lever K360



Offset roller lever K370



Roller lever H300

Thermoplastic angle roller lever	Thermoplastic offset roller lever	Metal lever with plastic roller Actuator type A according to EN 50041
> 50 N min. 10 mm/min, max. 1 m/s min. 60 mm/min, max. 1 m/s -	> 50 N min. 10 mm/min, max. 1 m/s min. 60 mm/min, max. 1 m/s -	> 50 N min. 10 mm/min, max. 1 m/s min. 60 mm/min, max. 1 m/s adjustable in 15° steps
PS-K360 103015399	PS-K370 103015400	PS-H300 103015401

Position switches

PS3xx – Actuator heads



Roller lever N300

Roller lever J300

Actuator heads

Actuator description	Roller lever N300	Roller lever J300
Actuator description	Length adjustable metal lever with plastic roller adjustable in 2 mm increments	Plastic rod, 200 mm Can only be used for positioning tasks Actuator type A according to EN 50041
Positive break force	> 50 N	-
Actuating speed	min. 10 mm/min, max. 1 m/s	min. 10 mm/min, max. 1 m/s
Snap action		
Slow action	min. 60 mm/min, max. 1 m/s	min. 60 mm/min, max. 1 m/s
Positioning the lever	adjustable in 15° steps	adjustable in 15° steps

Ordering data modular construction kit

Type designation	PS-N300	PS-J300
Ordering code	103015402	103015403

Switch travel diagrams

Actuator head	Actuator description	PS-N300	PS-J300
Snap action	Per NO contact / per NC contact		
Slow action	Per NO contact / per NC contact		
	1 NO / 1 NC with overlapping		
	2 NC with staggered contacts		

Contact closed

Contact open

Positive break travel / angle

Up-to-date without fail

The online product catalogue



For detailed information, check out
www.schmersal.net

Position switches

PS116 – Preferred types and ordering details



Position switch with actuator element	Connection	Switching system	NO contacts	NC contacts	Type designation	Material number	
S200 Basic switch	Connector plug	Snap action	1	1	PS116-Z11-ST-S200	103006651	
			1	2	PS116-Z12-ST-S200	103006662	
		Slow action	1	1	PS116-T11-ST-S200	103006652	
	connecting cable	Snap action	1	1	PS116-Z11-L200-S200	103006633	
			1	2	PS116-Z12-L200-S200	103006647	
		Snap action with latch	1	1	PS116-Z11R-L200-S200	103009907	
			0	2	PS116-Z02R-L200-S200	103012043	
		Slow action	1	1	PS116-T11-L200-S200	103006634	
	R200	Connector plug	Snap action	1	1	PS116-Z11-ST-R200	103006653
				0	2	PS116-Z02-ST-R200	103008391
1				2	PS116-Z12-ST-R200	103006663	
Snap action with latch			1	2	PS116-Z12R-ST-R200	103009897	
			Slow action	1	1	PS116-T11-ST-R200	103006654
				2	1	PS116-T21-ST-R200	103009215
connecting cable		Snap action	1	1	PS116-Z11-L200-R200	103006635	
			1	1	PS116-T11-L200-R200	103006636	
			1	2	PS116-T12-L200-R200	103006648	
		Slow action	1	1	PS116-Z11-L200-K200	103006655	
			1	2	PS116-Z12-L200-K200	103006664	
			1	1	PS116-Z11-L200-K200	103006637	
K210	Connector plug	Snap action	1	1	PS116-Z11-ST-K210	103006656	
			1	2	PS116-Z12-ST-K210	103009491	
		Slow action	1	1	PS116-T11-ST-K210	103006657	
	connecting cable	Snap action	2	1	PS116-T21-ST-K210	103013834	
			1	1	PS116-Z11-L200-K210	103006638	
			1	2	PS116-Z12R-L200-K210	103009906	
		Slow action	1	1	PS116-T11-L200-K210	103006639	
			Snap action	1	1	PS116-Z11-ST-K230	103006658
				0	2	PS116-T02-ST-K230	103014690
K230	Connector plug	Snap action	1	1	PS116-Z11-L200-K230	103006640	
			0	2	PS116-Z02-L200-K230	103011608	
	connecting cable	Snap action	1	2	PS116-Z12-ST-K240	103006665	
			1	1	PS116-Z11-L200-K240	103006641	
K240	Connector plug	Snap action	1	2	PS116-Z12-ST-K250	103006666	
			1	2	PS116-T12-ST-K250	103006667	
	connecting cable	Snap action	1	1	PS116-Z11-L200-K250	103006642	
			1	1	PS116-T11-L200-K250	103006643	
		Slow action	1	1	PS116-T11-L200-K250	103006643	
			1	2	PS116-T12-L200-K250	103015281	

Position switches

PS116 – Preferred types and ordering details



Position switch with actuator element	Connection	Switching system	NO contacts	NC contacts	Type designation	Material number	
H200	Connector plug	Snap action	1	1	PS116-Z11-ST-H200	103006659	
			1	2	PS116-Z12-ST-H200	103009490	
		Slow action	1	1	PS116-T11-ST-H200	103006660	
			1	2	PS116-T12-ST-H200	103006668	
			0	3	PS116-T03-ST-H200	103012315	
	connecting cable	Snap action	1	1	PS116-Z11-L200-H200	103006644	
			1	1	PS116-T11-L200-H200	103006645	
		Slow action	1	2	PS116-T12-L200-H200	103006649	
			1	1	PS116-Z11-ST-N200	103006661	
			1	2	PS116-Z12-ST-N200	103010921	
N200	Connector plug	Snap action	1	1	PS116-T11-ST-N200	103011367	
			2	0	PS116-T20-ST-N200	103010065	
		Slow action	1	2	PS116-T12-ST-N200	103011553	
			2	1	PS116-T21-ST-N200	103010067	
		connecting cable	Snap action	1	1	PS116-Z11-L200-N200	103006646
				1	2	PS116-Z12-L200-N200	103008748
	Slow action		1	2	PS116-T12-L200-N200	103006650	
			0	2	PS116-T02H-ST-J200	103014413	
	J200	Connector plug	Slow action with staggered contacts	0	2	PS116-T02H-ST-J200	103014413

Position switches

PS2xx – Preferred types and ordering details



Position switch with actuator element	Switching system	NO contacts	NC contacts	Type designation	Material number	
S200 Basic switch	PS215 Metal	Snap action	1	1	PS215-Z11-S200	103014952
			0	2	PS215-Z02-S200	103014953
			1	2	PS215-Z12-S200	103014954
		Slow action	1	1	PS215-T11-S200	103014977
			0	2	PS215-T02-S200	103014978
			1	2	PS215-T12-S200	103014979
	PS216 Thermoplastic	Snap action	1	1	PS216-Z11-S200	103013713
			0	2	PS216-Z02-S200	103015001
			1	2	PS216-Z12-S200	103015002
		Slow action	1	1	PS216-T11-S200	103015022
			0	2	PS216-T02-S200	103015023
			1	2	PS216-T12-S200	103015024
	PS226 Thermoplastic	Snap action	1	1	PS226-Z11-S200	103015048
			0	2	PS226-Z02-S200	103015049
			1	2	PS226-Z12-S200	103015050
		Slow action	1	1	PS226-T11-S200	103015073
			0	2	PS226-T02-S200	103015074
			1	2	PS226-T12-S200	103015075
R200	PS215 Metal	Snap action	1	1	PS215-Z11-R200	103014955
		Slow action	1	1	PS215-T11-R200	103014981
	PS216 Thermoplastic	Snap action	1	1	PS216-Z11-R200	103015003
			0	2	PS216-Z02-R200	103015004
			1	2	PS216-Z12-R200	103015005
		Slow action	1	1	PS216-T11-R200	103015028
			0	2	PS216-T02-R200	103015029
			1	2	PS216-T12-R200	103015030
	PS226 Thermoplastic	Snap action	1	1	PS226-Z11-R200	103015051
		Slow action	1	1	PS226-T11-R200	103015076

Position switches

PS2xx – Preferred types and ordering details



Position switch with actuator element		Switching system	NO contacts	NC contacts	Type designation	Material number	
K200	PS216 Thermoplastic	Snap action	1	1	PS216-Z11-K200	103015006	
		Slow action	1	1	PS216-T11-K200	103015031	
K210	PS215 Metal	Snap action	1	1	PS215-Z11-K210	103014960	
		Slow action	1	1	PS215-T11-K210	103015008	
	PS216 Thermoplastic	Snap action	1	1	PS216-Z11-K210	103015008	
		Slow action	1	1	PS216-T11-K210	103015033	
K230	PS215 Metal	Snap action	1	1	PS215-Z11-K230	103014963	
		Slow action	1	1	PS215-T11-K230	103014988	
	PS216 Thermoplastic	Snap action	1	1	PS216-Z11-K230	103015010	
		Slow action	1	1	PS216-T11-K230	103015035	
	K240	PS215 Metal	Slow action	1	1	PS215-T11-K240	103014991
			Snap action	1	1	PS216-Z11-K240	103015013
PS216 Thermoplastic		Slow action	1	1	PS216-T11-K240	103015038	
	PS226 Thermoplastic	Snap action	1	1	PS226-Z11-K240	103015061	
K250	PS216 Thermoplastic	Snap action	1	1	PS216-Z11-K250	103015015	
		Slow action	1	1	PS216-T11-K250	103015040	
H200	PS215 Metal	Slow action	1	1	PS215-T11-H200	103014995	
		Snap action	1	1	PS216-Z11-H200	103013857	
	PS216 Thermoplastic	Snap action	1	2	PS216-Z12-H200	103015017	
		Slow action	1	1	PS216-T11-H200	103015042	
		Slow action	1	2	PS216-T12-H200	103015043	
		Slow action	1	2	PS216-T12-H200	103015043	
N200	PS215 Metal	Snap action	1	1	PS215-Z11-N200	103014972	
		Slow action	1	1	PS215-T11-N200	103014997	
	PS216 Thermoplastic	Snap action	1	1	PS216-Z11-N200	103015018	
		Snap action	1	2	PS216-Z12-N200	103015019	
		Slow action	1	1	PS216-T11-N200	103015044	
		Slow action	1	2	PS216-T12-N200	103015045	
	J200	PS215 Metal	Snap action	1	1	PS215-Z11-J200	103014974
		PS216 Thermoplastic	Snap action	1	1	PS216-Z11-J200	103015020

Position switches

PS3xx – Preferred types and ordering details



Position switch with actuator element	Switching system	NO contacts	NC contacts	Type designation	Material number		
S200 Basic switch	PS315 Metal	Snap action	1	1	PS315-Z11-S200	103015406	
			0	2	PS315-Z02-S200	103015407	
			1	2	PS315-Z12-S200	103015408	
		Slow action	1	1	PS315-T11-S200	103015412	
			0	2	PS315-T02-S200	103015414	
			1	2	PS315-T12-S200	103015415	
	PS316 Thermoplastic	Snap action	1	1	PS316-Z11-S200	103015409	
			0	2	PS316-Z02-S200	103015410	
			1	2	PS316-Z12-S200	103015411	
		Slow action	1	1	PS316-T11-S200	103015417	
			0	2	PS316-T02-S200	103015418	
			1	2	PS316-T12-S200	103015419	
	S300	PS315 Metal	Snap action	1	1	PS315-Z11-S300	103015096
				0	2	PS315-Z02-S300	103015097
				1	2	PS315-Z12-S300	103015098
Slow action			1	1	PS315-T11-S300	103015112	
			0	2	PS315-T02-S300	103015113	
			1	2	PS315-T12-S300	103015114	
PS316 Thermoplastic		Snap action	1	1	PS316-Z11-S300	103015129	
			0	2	PS316-Z02-S300	103015130	
			1	2	PS316-Z12-S300	103015131	
		Slow action	1	1	PS316-T11-S300	103015146	
			0	2	PS316-T02-S300	103015147	
			1	2	PS316-T12-S300	103015148	
R300		PS315 Metal	Snap action	1	1	PS315-Z11-R300	103015099
				0	2	PS315-Z02-R300	103015100
			Slow action	1	1	PS315-T11-R300	103015116
	0	2		PS315-T02-R300	103015117		
	PS316 Thermoplastic	Snap action	1	1	PS316-Z11-R300	103015132	
			0	2	PS316-Z02-R300	103015133	
		Slow action	1	1	PS316-T11-R300	103015152	
			0	2	PS316-T02-R300	103015153	

Position switches

PS3xx – Preferred types and ordering details



Position switch with actuator element		Switching system	NO contacts	NC contacts	Type designation	Material number
K360	PS315 Metal	Snap action	1	1	PS315-Z11-K360	103015102
		Slow action	1	1	PS315-T11-K360	103015119
	PS316 Thermoplastic	Snap action	1	1	PS316-Z11-K360	103015135
		Slow action	1	1	PS316-T11-K360	103015155
K370	PS315 Metal	Snap action	1	1	PS315-Z11-K370	103015104
		Slow action	1	1	PS315-T11-K370	103015121
	PS316 Thermoplastic	Snap action	1	1	PS316-Z11-K370	103015137
		Slow action	1	1	PS316-T11-K370	103015157
H300	PS315 Metal	Snap action	1	1	PS315-Z11-H300	103015106
		Slow action	1	1	PS315-T11-H300	103015123
	PS316 Thermoplastic	Snap action	1	1	PS316-Z11-H300	103015139
		Slow action	1	1	PS316-T11-H300	103015159
			1	2	PS316-T12-H300	103015160
N300	PS315 Metal	Snap action	1	1	PS315-Z11-N300	103015108
		Slow action	1	1	PS315-T11-N300	103015125
	PS316 Thermoplastic	Snap action	1	1	PS316-Z11-N300	103015141
		Slow action	1	1	PS316-T11-N300	103015161
			1	2	PS316-T12-N300	103015162
J300	PS315 Metal	Snap action	1	1	PS315-Z11-J300	103015110
		Slow action	1	1	PS315-T11-J300	103015127
	PS316 Thermoplastic	Snap action	1	1	PS316-Z11-J300	103015143
		Slow action	1	1	PS316-T11-J300	103015163

Addresses

■ **Hauptsitz – Headquarters**
K.A. Schmersal GmbH & Co. KG
Industrielle Sicherheitssysteme
 Postfach 24 02 63,
 42232 Wuppertal
 Möddinghofe 30
 D-42279 Wuppertal
 Phone: +49 202 6474-0
 Fax: +49 202 6474-100
 info@schmersal.com
 www.schmersal.com

Germany – Northern region

■ **Wettenberg**
K.A. Schmersal GmbH & Co. KG
Vertriebsbüro Wettenberg
 Im Ostpark 2
 D-35435 Wettenberg
 Phone: +49 641 9848-575
 Fax: +49 641 9848-577
 vbwettenberg@schmersal.com

■ **Hamburg / Münster**
K.A. Schmersal GmbH & Co. KG
Vertriebsbüro Hamburg
 Innungsstraße 3
 D-21244 Buchholz i.d.N.
 Phone: +49 41 81 9220-0
 Fax: +49 41 81 9220-20
 vbhamburg@schmersal.com

■ **Berlin**
**KSA Komponenten der Steuerungs-
 und Automatisierungstechnik GmbH**
 Pankstr. 8-10 / Aufg. L
 D-13127 Berlin
 Phone: +49 30 474824-00
 Fax: +49 30 474824-05
 info@ksa-gmbh.de
 www.ksa-gmbh.de

■ **Hannover**
ELTOP GmbH
 Robert-Bosch-Str. 8
 D-30989 Gehrden
 Phone: +49 51 089273-20
 Fax: +49 51 089273-21
 eltop@eltop.de
 www.eltop.de

■ **Köln**
Stollenwerk
Technisches Büro GmbH
 Scheuermühlenstr. 40
 D-51147 Köln
 Phone: +49 2203 96620-0
 Fax: +49 2203 96620-30
 info@stollenwerk.de
 www.stollenwerk.de

■ **Siegen**
Siegfried Klein
Elektro-Industrie-Vertretungen
 In der Steinwiese 46
 D-57074 Siegen
 Phone: +49 271 6778
 Fax: +49 271 6770
 info@sk-elektrotechnik.de
 www.sk-elektrotechnik.de

■ **Leipzig**
K.A. Schmersal GmbH & Co. KG
Vertriebsbüro Leipzig
 Servicepark
 Druckereistraße 4
 D-04159 Leipzig
 Phone: +49 341 48734-50
 Fax: +49 341 48734-51
 vbleipzig@schmersal.com

Germany – Southern region

■ **Nürnberg**
K.A. Schmersal GmbH & Co. KG
Vertriebsbüro Nürnberg
 Lechstraße 21
 D-90451 Nürnberg
 Phone: +49 911 6496053
 Fax: +49 911 63290729
 vbnuernberg@schmersal.com

■ **Saarland**
**Herbert Neundörfer Werks-
 vertretungen GmbH & Co. KG**
 Am Campus 5
 D-66287 Göttingen
 Phone: +49 6825 9545-0
 Fax: +49 6825 9545-99
 info@herbert-neundoerfer.de
 www.herbert-neundoerfer.de

■ **Bayern Süd**
INGAM Ing. Adolf Müller GmbH
Industrievertretungen
 Elly-Staegmeyr-Str. 15
 D-80999 München
 Phone: +49 89 8126044
 Fax: +49 89 8126925
 info@ingam.de
 www.ingam.de

■ **Bietigheim**
K.A. Schmersal GmbH & Co. KG
Technologiezentrum
 Pleidelsheimer Straße 15
 74321 Bietigheim-Bissingen
 Phone: +49 7142 91028-0
 Fax: +49 7142 91028-28
 tzbw@schmersal.com

Europe

■ **Austria – Österreich**
AVS-Schmersal Vertriebs Ges. m.b.H.
 Biröstraße 17
 1232 Wien
 Phone: +43-1-6 10 28
 Fax: +43-1-6 10 28-1 30
 info@avs-schmersal.at
 www.avs-schmersal.at

■ **Belgium – Belgien**
Schmersal Belgium NV/SA
 Nieuwlandlaan 73
 Industriezone B413
 3200 Aarschot
 Phone: +32-16-57 16 18
 Fax: +32-16-57 16 20
 info@schmersal.be
 www.schmersal.be

■ **Bulgaria – Bulgarien**
CDL Sensorik OOD
 Stefan Caragea Street
 No 10 Office 4
 7002 Ruse City
 Phone: +359-0 40-7 35 16 55 25
 Fax: +359-0 40-2 69 25 33 44
 office@cdlsensorik.com
 www.cdlsensorik.com

■ **Bosnia and Herzegovina**
Tipteh d.o.o. Sarajevo
 Ulica Ramiza Salčina 246
 71000 Sarajevo
 Phone: +387- 61 92 36 23
 nadir.durmic@tipteh.ba
 www.tipteh.ba

■ **Croatia – Kroatien**
Tipteh Zagreb d.o.o.
 Pescanska 170
 10000 Zagreb
 Phone: +385-1-3 81 65 74
 Fax: +385-1-3 81 65 77
 tipteh@tipteh.hr

■ **Czech Republic – Tschech. Republik**
MERCOM COMPONENTA s.r.o.
 Bechyňská 640
 199 00 Praha 9 – Letňany
 Phone: +4 20-267 31 46 40-2
 mercom@mercom.cz
 www.mercom.cz
 www.schmersal.cz

■ **Denmark – Dänemark**
Schmersal Danmark A/S
 Lautruphøj 1-3
 2750 Ballerup
 Phone: +45-70 20 90 27
 Fax: +45-70 20 90 37
 info@schmersal.dk
 www.schmersal.dk

■ **Finland – Finnland**
Advancetec Oy
 Äyritie 12 B
 01510 Vantaa
 Phone: +3 58-2 07 19 94 30
 Fax: +3 58-9 35 05 26 60
 advancetec@advancetec.fi
 www.schmersal.fi

■ **France – Frankreich**
Schmersal France
 BP 18 - 38181 Seyssins Cedex
 8, rue Raoul Follereau
 38180 Seyssins
 Phone: +33-4 76 84 23 20
 Fax: +33-4 76 48 34 22
 info-fr@schmersal.com
 www.schmersal.fr

■ **Greece – Griechenland**
Kalamarakis Sapounas S.A.
Ionias & Neromilou
 PO Box 46566 Athens
 13671 Chamomilos Acharnes
 Athens
 Phone: +30-210-2 40 60 00-6
 Fax: +30-210-2 40 60 07
 ksa@ksa.gr
 www.ksa.gr

■ **Hungary – Ungarn**
**NTK Ipari-Elektronikai és
 Kereskedelmi Kft**
 Gesztenyefa u. 4.
 9027 Győr
 Phone: +36-96-52 32 68
 Fax: +36-96-43 00 11
 info@ntk-kft.hu
 www.ntk-kft.hu

■ **Iceland – Island**
Reykjafell Ltd.
 Skipholt 35
 125 Reykjavik
 Phone: +354-5 88 60 10
 Fax: +354-5 88 60 88
 reykjafell@reykjafell.is

■ **Italy – Italien**
Schmersal Italia s.r.l.
 Via Molino Vecchio, 206
 25010 Borgosatollo, Brescia
 Phone: +39-0 30-2 50 74 11
 Fax: +39-0 30-2 50 74 31
 info@schmersal.it
 www.schmersal.it

■ **Macedonia – Mazedonien**
Tipteh d.o.o. Skopje
 Ul. Jani Lukrovski br. 2/33
 1000 Skopje
 Phone: +389-70-39 94 74
 Fax: +389-23-17 41 97
 tipteh@on.net.mk

■ **Netherlands – Niederlande**
Schmersal Nederland B.V.
 Lorentzstraat 31
 3846 AV Harderwijk
 Phone: +31-3 41-43 25 25
 Fax: +31-3 41-42 52 57
 info-nl@schmersal.com
 www.schmersal.nl

■ **Norway – Norwegen**
Schmersal Norge
 Hoffsvæien 92
 0377 Oslo
 Phone: +47-22 06 00 70
 Fax: +47-22 06 00 80
 info-no@schmersal.com
 www.schmersal.no

■ **Poland – Polen**
Schmersal - Polska Sp.j.
 ul. Baletowa 29
 02-867 Warszawa
 Phone: +48-22-8 16 85 78
 Fax: +48-22-8 16 85 80
 info@schmersal.pl
 www.schmersal.pl

■ **Portugal – Portugal**
Schmersal Ibérica, S.L.
 Apartado 30
 2626-909 Póvoa de Sta. Iria
 Phone: +351 - 21 959 38 35
 info-pt@schmersal.com
 www.schmersal.pt

■ **Romania – Rumänien**
CD SENSORIC SRL
 Str. George Enescu 21
 550248 Sibiu
 Phone: +40-2 69-25 33 33
 Fax: +40-2 69-25 33 44
 proiecte@cdl.ro
 www.cdl.ro

■ **Russia – Russland**
OOO AT electro Moskau
 ul. Avtosavodskaya 16-2
 109280 Moskau
 Phone: +7-49 5-9 21 44 25
 Fax: +7-49 5-9 26 46 45
 info@at-e.ru
 www.at-e.ru

OOO AT electro Petersburg
 Polytechniskaya str, d.9,B
 194021 St. Petersburg
 Phone: +7-81 2-7 03 08 17
 Fax: +7-81 2-7 03 08 34
 spb@at-e.ru

AT- Electronics Ekaterinburg
 Bebelya str. 17, room 405
 620034 Ekaterinburg
 Phone: +7-34 3-2 45 22 24
 Fax: +7-34 3-2 45 98 22
 ural@at-e.ru

■ **Slovakia – Slowakei**
MERCOM COMPONENTA s.r.o.
 Bechyňská 640
 199 00 Praha 9 – Letňany
 Phone: +4 20-267 31 46 40-2
 mercom@mercom.cz
 www.mercom.cz
 www.schmersal.cz

■ **Slovenia – Slowenien**
Tipteh d.o.o.
 Ulica Ivana Roba 21
 1000 Ljubljana
 Phone: +386-1-2 00 51 50
 Fax: +386-1-2 00 51 51
 info@tipteh.si
 www.tipteh.si

■ **Spain – Spanien**
Schmersal Ibérica, S.L.
 Rambla de los Países Catalanes 12
 08800 Vilanova i la Geltrú
 Phone: +34-902 56 64 57
 info-es@schmersal.com
 www.schmersal.es

■ **Sweden – Schweden**
Schmersal Nordiska AB
 F O Petersens gata 28
 421 31 Västra Frölunda
 Phone: +46-31-3 38 35 00
 Fax: +46-31-3 38 35 39
 info-se@schmersal.com
 www.schmersal.se

■ **Switzerland – Schweiz**
Schmersal Schweiz AG
 Moosmattstraße 3
 8905 Arni
 Phone: +41-43-3 11 22 33
 Fax: +41-43-3 11 22 44
 info-ch@schmersal.com
 www.schmersal.ch

Addresses

- **Turkey – Türkei**
Entek Otomasyon Urunleri San. ve Tic. A.S.
 Mahmutbey Mah.
 Tasocagi Yolu Cad. No: 9 Entek Plaza
 34218 Bagcilar / Istanbul
 Phone: +90 850 201 4141
 Fax: +90 212 320 1188
 info@entek.com.tr
 www.entek.com.tr
- **United Kingdom – Großbritannien**
Schmersal Ltd.
 Sparrowhawk Close
 Enigma Business Park
 Malvern Worcestershire WR14 1GL
 Phone: +44-16 84-57 19 80
 Fax: +44-16 84-56 02 73
 support@schmersal.co.uk
 www.schmersal.co.uk
- **Ukraine – Ukraine**
VBR Ltd.
 41, Demiyivska Str.
 03040 Kyiv Ukraine
 Phone: +38 (044) 259 09 55
 Fax: +38 (044) 259 09 55
 office@vbr.com.ua
 www.vbr-electric.com.ua/schmersal
- **Chile – Chile**
Vitel S.A.
 francisco@vitel.cl
 www.vitel.cl
SOLTEX
 central@soltext.cl
 www.soltext.com.cl
INSTRUTEC
 gcaceres@instrutec.cl
 www.instrutec.cl
OEG
 jmp@oegggroup.com
 www.oegggroup.cl
EECOL INDUSTRIAL ELECTRIC
 ventas@eecol.cl
 www.eecol.cl
- **PR China – VR China**
Schmersal Industrial Switchgear (Shanghai) Co. Ltd.
 Cao Ying Road 3336
 201712 Shanghai / Qingpu
 Phone: +86-21-63 75 82 87
 Fax: +86-21-63 75 82 97
 sales@schmersal.com.cn
 www.schmersal.com.cn
- **Colombia – Kolumbien**
EQUIPELCO
 aospina@equipelco.com
 www.equipelco.com
SAMCO
 jvargas@samcoingenieria.com
 www.samcoingenieria.com
- **Ecuador – Ecuador**
SENSORTEC S.A.
 AV. Napo y Pinto Guzmán
 Quito
 Phone: +593 091 40 27 65
 +593 095 04 86 11
 infogy@sensortecsa.com
 www.sensortecsa.com
- **Guatemala – Guatemala**
PRESTELECTRO
 AV Petapa 44-22,
 Zona 12; Cent. Com Florencia 01012
 Phone: +502 24 42-33 46
 Anabella.Barrios@prestelectro.com
 www.prestelectro.com
- **India – Indien**
Schmersal India Private Limited
 Plot No G 7/1,
 Ranjangaon MIDC,
 Taluka Shirur,
 District Pune 412220, India
 Phone: +91 21 38 61 47 00
 Fax: +91 20 66 86 11 14
 info-in@schmersal.com
 www.schmersal.in
- **Indonesia – Indonesien**
PT. Wiguna Sarana Sejahtera
 Jl. Daan Mogot Raya No. 47
 Jakarta Barat 11470
 Phone: +62-21-5 63 77 70-2
 Fax: +62-21-5 66 69 79
 email@ptwiguna.com
 www.ptwiguna.com
- **Iran – Iran**
Omid Electric
 No. 1-5, 1st Floor, Azizi passage,
 Southern Lalehzar Str. Tehran
 ZIP: 1144944181
 Phone: +98 21 33924027
 +98 21 33911022
 Fax: +98 21 33936635
 sales@omidelectric.com
- **Israel – Israel**
A.U. Shay Ltd.
 23 Imber St. Kiriat. Arieah.
 P.O. Box 10049
 Petach Tikva 49222 Israel
 Phone: +9 72-3-9 23 36 01
 Fax: +9 72-3-9 23 46 01
 shay@uriel-shay.com
 www.uriel-shay.com
- **Japan – Japan**
Schmersal Japan Branch Office
 3-39-8 Shoan, Sugunami-ku
 Tokyo 167-0054
 Phone: +81-3-3247-0519
 Fax: +81-3-3247-0537
 safety@schmersaljp.com
 www.schmersal.jp
- **Korea – Korea**
Mahani Electric Co. Ltd.
 20, Gungmal-ro, Gwacheon-si,
 Gyeonggi-do 427-060, Korea
 Phone: +82-2-21 94-33 00
 Fax: +82-2-21 94-33 97
 yskim@mec.co.kr
 www.mec.co.kr
- **Litauen/Estland/Lettland**
BOPLALIT
 Mus galite rasti:
 Baltų pr. 145, LT-47125, Kaunas
 Phone: +370 37 298989
 Phone: +370 37 406718
 infoboplalit.lt
 www.boplalit.lt
- **Malaysia – Malaysien**
Ingermark (M) SDN.BHD
 No. 29, Jalan KPK 1/8
 Kawasan Perindustrian Kundang
 48020 Rawang, Selangor Darul Ehsan
 Phone: +6 03-60-34 27 88
 Fax: +6 03-60-34 21 88
 enquiry@ingermark.com
- **Mexico – Mexiko**
ISEL SA de CV
 mario.c@isel.com.mx
 www.isel.com.mx
INNOVATIVE AUTOMOTION SOLUTIONS
 ias@iasmx.com
 www.iasautomation.com.mx
EASA ENERGIA Y AUTOMATIZACION
 ias@iasmx.com
 www.iasautomation.com.mx
DINAMICA S.A de C.V
 ias@iasmx.com
 www.iasautomation.com.mx
SIGRAMA S.A de C.V
 ias@iasmx.com
 www.iasautomation.com.mx
VGR TECHNOLOGIES
 ias@iasmx.com
 www.iasautomation.com.mx
- **New Zealand – Neuseeland**
Hamer Automation
 85A Falsgrave Street
 Phillipstown
 Christchurch, New Zealand
 Phone: +64-33 66 24 83
 Fax: +64-33 79 13 79
 sales@hamer.co.nz
 www.hamer.co.nz
- **Pakistan – Pakistan**
eurotech JLT
 Office No.3404, 34th Floor,
 HDS Tower, Sheikh Zayed Road,
 Jumeirah Lakes Towers (JLT),
 P.O.Box 643650, Dubai, UAE
 Phone: +9 71-4-4 21 46 00
 Fax: +9 71-4-4 21 46 01
 sales@eurotech.ae
 www.eurotech.ae
- **Paraguay – Paraguay**
Brasguay S.R.L.
 R. Internaciona 07
 KM 14 ; Minga Guazu
 Phone: +595 (61) 583-418/218/577
 brasguay@brasguay.com.py
 www.brasguay.com.py
- **Peru – Peru**
Fametal S.A.
 fametal@fametal.com
 www.fametal.com
AYD
 informes@ayd.com.pe
 www.ayd.com.pe
- **Serbia/Montenegro – Serbien/Montenegro**
Tipteh d.o.o.
 Toplice Milana 14A
 11050 Belgrade
 Phone: +3 81-11-2 89 22 50
 Fax: +3 81-11-3 01 83 26
 www.tipteh.rs
- **Singapore – Singapur**
AZAREL International Pte Ltd.
 Empire Techno Centre
 30 Kaki Bukit Road 3 #01-10
 Singapore 417819
 Phone: +65-67 42 29 88
 Fax: +65-67 42 26 28
 sales@azarel.com.sg
 www.azarel.com.sg
- **South Africa – Südafrika**
A+A Dynamic Distributors (Pty) Ltd.
 20 - 24 Augusta Road
 Regents Park
 2197 Booyens
 Phone: +27-11-6 81 59 00
 Fax: +27-11-4 35 13 18
 awkayser@iafrica.com
- **Taiwan – Taiwan**
Golden Leader Camel Ent. Co., Ltd.
 No. 453-7, Pei Tun Rd.
 Taichung City 40648, Taiwan
 Phone: +886-4-22 41 29 89
 Fax: +886-4-22 41 29 23
 camel88@ms46.hinet.net
 www.leadercamel.com.tw
- **Thailand – Thailand**
M. F. P. Engineering Co. Ltd.
 64-66 Buranasart Road
 Sanchaoporsva
 Bangkok 10200
 Phone: +66-2-2 26 44 00
 Fax: +66-2-2 25 67 68
 info@mfpthai.com
 www.mfpthai.com
- **United Arab Emirates – Vereinigte Arabische Emirate**
Multitech fze
 Office No.3404, 34th Floor,
 HDS Tower, Sheikh Zayed Road,
 Jumeirah Lakes Towers (JLT),
 P.O.Box 643650, Dubai, UAE
 Phone: +9 71-4-4 21 46 00
 Fax: +9 71-4-4 21 46 01
 sales@eurotech.ae
 www.eurotech.ae
- **USA – USA**
Schmersal Inc.
 15 Skyline Drive
 Hawthorne, NY 10532
 Phone: +1-(0) 8 88-4 96-51 43
 Fax: +1-(0) 9 14-3 47-15 67
 infousa@schmersal.com
 www.schmersalusa.com
- **Uruguay – Uruguay**
Gliston S.A.
 Pedernal 1896 – Of. 203
 Montevideo
 Phone: +598 (2) 2 00 07 91
 colmedo@gliston.com.uy
 www.gliston.com.uy
- **Venezuela – Venezuela**
EMI Equipos y Sistemas C.A.
 Calle 10, Edf. Centro Industrial
 Martinisi, Piso 3, La Urbina, Caracas
 Phone: +58 (212) 2 43 50 72
 ventas@emi-ve.com
 www.emi-ve.com
- **Vietnam – Vietnam**
Ingermark (M) Sdn Bhd, Rep Office
 No. 10 Alley 1/34, Lane 1,
 Kham Thien Str.,
 Kham Thien Ward Dong Da Dist.,
 10000 Hanoi, Vietnam.
 Phone: +04-35 16 27 06
 Fax: +04-35 16 27 05
 ingvietn18@gmail.com
 www.ingermark.com



The Schmersal Group

In the demanding field of machine safety, the owner-managed Schmersal Group is one of the international market and component leaders. The company, which was founded in 1945, has a workforce of about 2000 people and seven manufacturing sites on three continents along with its own companies and sales partners in more than 60 nations.

Customers of the Schmersal Group include global players from the area of mechanical engineering and plant manufacturing as well as operators of machinery. They profit from the company's extensive expertise as a provider of systems and solutions for machine safety. Furthermore, Schmersal specialises in various areas including foodstuff production, the packaging industry, machine tool industry, lift switchgear, heavy industry and the automotive industry.

A major contribution to the range of products and services offered by the Schmersal Group is made by tec.nicum with its comprehensive range of services: certified Functional Safety Engineers advise machinery manufacturers and machinery operators in all aspects relating to machinery and occupational safety – and do so with product and manufacturer neutrality. Furthermore, they plan and realise complex solutions for safety around the world in close collaboration with the clients.

Safety Products



- Safety switches and sensors, solenoid interlocks
- Safety controllers and safety relay modules, safety bus systems
- Optoelectronic and tactile safety devices
- Automation technology: position switches, proximity switches

Safety Systems



- Complete solutions for safeguarding hazard areas
- Individual parametrisation and programming of safety controllers
- Tailor-made safety technology – be it for individual machines or a complex production line
- Industry-specific safety solutions

Safety Services



- tec.nicum academy – Seminars and training
- tec.nicum consulting – Consultancy services
- tec.nicum engineering – Design and technical planning
- tec.nicum integration – Execution and installation

The details and data referred to have been carefully checked.
Technical amendments and errors possible.

www.schmersal.com



x.000 / L+W / 06.2017 / Teile-Nr. 103015869 / EN / Ausgabe 01

 **SCHMERSAL**
Safe solutions for your industry