

SAFEONE DN3PD2

Manual

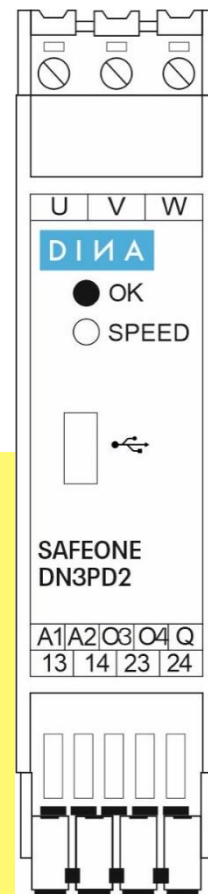

Safety switchgear to monitor the speed
of three-phase and single-phase motors without sensor

DINA Elektronik GmbH

Esslinger Straße 84
72649 Wolfschlugen
Deutschland

Phone +49 7022 9517 0

Mail info@dina.de

Web www.dina.de

© Copyright by DINA Elektronik GmbH 2023

All parts of this documentation are protected by copyright.

Any use beyond that permitted under copyright law is not permitted without express written consent from the publisher. This applies in particular to the reproduction, distribution and translation of this documentation or parts thereof, as well as the storage and processing of this content using electronic data processing systems.

The information contained in this documentation corresponds to the technical state of the product at the time these operating instructions were published.

This manual is valid for:

Description	ID-No.
--------------------	---------------

DN3PD2	34PD01
	34PD02
	34PD03
	34PD04

Legal information

Handbook:	Hardware
Target group:	Electricians, electrical designers
Editor:	DINA Elektronik GmbH
File name:	DN3PD2-Handbuch-e-202306.docx
Language:	ENG
Publication as at:	14. July 2023

Content

1	Structure of the document	1
1.1	Conventions.....	1
1.1.1	Emphasizing information	1
1.1.2	Emphasizing paragraphs using typography	1
1.1.3	Emphasizing words using typography	1
1.2	Your opinion is important to us!.....	2
2	Safety.....	3
2.1	Warnings	3
2.1.1	Function of warnings	3
2.1.2	Design of warnings.....	3
2.1.3	Hazard symbols.....	4
2.2	Qualification of personnel	4
2.2.1	Electrician.....	4
2.2.2	Electrical designers	4
2.3	Intended use and improper use	5
2.3.1	Certification data	5
4	Product description.....	10
4.1	Function description.....	10
4.1.1	Speed monitoring	10
4.2	Acknowledge function.....	11
4.3	Start-up monitoring	11
4.4	Switch-off delay	13
4.5	Switch-on delay	13
4.6	Advanced settings	14
4.7	Minimum switch-off time	14
4.8	Password.....	15
4.9	Validation.....	15
4.10	Display.....	15
4.11	Diagnosis.....	15
4.12	Signal outputs.....	15
4.13	USB interface	16
4.14	Connections.....	16

4.15	Block diagram	17
5	Applications	18
5.1	Motor with frequency converter	18
5.2	Motor with star-delta circuit	18
5.3	Single-phase motor	18
5.4	Synchronous motor	19
6	Diagnostics and switching status displays	20
6.1	LED indicators	20
6.2	Error messages	21
7	Configuration	22
7.1	System requirements	23
7.2	Installation of the Configurations-Software	23
7.3	Connection to the PC	24
7.4	User interface	24
7.5	Parameterization	25
7.6	Machine data	26
7.8	Create a project	26
7.9	Edit and Change password	26
7.10	Diagnose	27
7.11	Validation	29
8	Example of application	31
9	Order information	32
10	Technical data	32
10.1	Supply	32
10.2	Digital inputs	32
10.3	Measuring inputs	32
10.4	Signal outputs	33
10.5	Contact outputs	33
10.6	General data	34
10.7	Connection data	34
10.8	Environmental conditions	35
10.9	Dimensions	35
10.10	Safety technical data	35

10.11	Safety-related parameters in accordance with DIN EN ISO 13849-1:2016-06	35
10.12	Safety-related parameters in accordance with EN ISO 61508-High Demand.....	35
11	Installation and removal.....	37
11.1	Installing a module.....	37
11.1.1	Overview	37
11.2	Removing a module.....	37

1 Structure of the document

1.1 Conventions

Information of particular important is emphasized in this documentation through the use of symbols, typography or formulations.

1.1.1 Emphasizing information

The following symbols indicate important information:



Degree of hazard (e.g. WARNING): Triangular symbols indicate the degree of hazard in warnings.



Type of hazard (e.g. electrical shock – dangerous voltage): Triangular symbols indicate the type of hazard in warnings.



Information: Additional clarification.



Tip: Additional information to help optimize the workflow.

1.1.2 Emphasizing paragraphs using typography

The following typography is used to emphasize paragraphs with special functions:



Indicates an instruction.



Indicates an expected reaction.



Indicates an unexpected reaction.



Indicates an item in a list.

1.1.3 Emphasizing words using typography

The following typography is used to emphasize words with special functions:

(1)

Represents a numbered item in a figure.

→

Indicates a cross-reference to another page, figure or document.

1.2 Your opinion is important to us!

We do all we can to provide complete, accurate documentation for the product. If you have any suggestions for improvement or advice for us, please share your thoughts with us. Send us your comments by e-mail to the following address.

E-mail: info@dina.de

2 Safety

2.1 Warnings

2.1.1 Function of warnings

Warnings warn users about hazards when handling the product. The hazards are classified, specified, described and supplemented with information about how to avoid them.

- If there is a warning before a list of instructions, the hazard is present throughout the entire activity.
- If there is a warning immediately before an instruction, the hazard is present during the next step.

2.1.2 Design of warnings

All warnings are indicated by a signal word and a warning symbol. The different combinations of the signal word and warning symbol indicate the degree of danger.

**DANGER**

For an immediate hazard that will result in severe injuries or death.

**WARNING**

For an immediate hazard that could result in severe injuries or death.

**CAUTION**

For a potentially hazardous situation that could result in injuries.

**CAUTION**

For a potentially harmful situation in which the product or an item near it could be damaged.

**CAUTION**

For a hazard that could cause environmental damage.

2.1.3 Hazard symbols

**Note**

The warning symbol may be present alongside another hazard symbol that represents the type of hazard, in order to attract the reader's attention.

Hazard symbols are indicated by a triangular symbol in the context of warnings. The following hazard symbols are used in this documentation:



Electric shock – dangerous voltage!

2.2 Qualification of personnel

DINA Elektronik GmbH distinguishes between specialist staff with different qualifications when it comes to carrying out work on the product. The minimum required qualifications are specified for each task and are defined as follows:

2.2.1 Electrician

Specialist who installs, maintains and repairs the electrical system in the product. A specialist is a person whose specialist training means that they have the knowledge and experience, including knowledge of relevant regulations, necessary to assess the work assigned to them and the potential hazards.

**Note**

When evaluating a person's specialist training, multiple years of work in the relevant field may also be taken into account.

→ **DIN VDE 1000-10** Requirements for persons working in a field of electrical engineering.

2.2.2 Electrical designers

Specialists who design the electrical system and the product. A specialist is a person whose specialist training means that they have the knowledge and experience, including knowledge of relevant regulations, necessary to assess the work assigned to them and the potential hazards.

**Note**

When evaluating a person's specialist training, multiple years of work in the relevant field may also be taken into account.

→ **DIN VDE 1000-10** Requirements for persons working in a field of electrical engineering.

2.3 Intended use and improper use

The product has exclusively been developed for use for the purpose described here. The specifications set out in these operating instructions must be strictly complied with.

- **DN3PD2** is a safety switchgear to monitor the speed of three-phase and single-phase motors without sensor.
- The safety module is intended for use on machines and plants to prevent hazards from arising.

Any other form of use is regarded as improper use.

If the product is

- not used as intended,
- improperly maintained or
- incorrectly operated,

the manufacturer will not assume any liability for any damage that results. In this case, the risk shall be borne exclusively by the user.

2.3.1 Certification data

The product is certified as safety equipment in accordance with:

<ul style="list-style-type: none"> ▪ DIN EN ISO 13849-1:2015 Category 4, PLe 	
<ul style="list-style-type: none"> ▪ EC type examination certificate 	Notified body: TÜV Rheinland Industrie Service GmbH Am Grauen Stein 51105 Köln Germany NB 0035
<ul style="list-style-type: none"> ▪ EMC Directive 	Certified by: ELMAC GmbH Bondorf
<ul style="list-style-type: none"> ▪ CNL, USL 	File E227037
<ul style="list-style-type: none"> ▪ QA system certified as per DIN EN ISO 9001:2015 	Certified by: DQS GmbH, 60433 Frankfurt am Main, Germany



Note

You can download the certificates from our website:

→ <https://www.dina.de/downloads>

2.4 Documentation

Operating instructions contain instructions on how to use a product safely, correctly and cost-effectively. Follow the instructions in these operating instructions in order to prevent hazards, avoid repair costs and standstill, and improve the reliability and service life of the product. You must read the operating instructions and ensure that you understand them.



► Before working with the product, read the documentation

- SAFEONE DN3PD2 Hardware manual

You can find them at www.dina.de/downloads.

► Always ensure that the operating instructions are available where the product is in use.

2.5 Safety regulations

The safety regulations listed below must always be complied with. In the event that these safety regulations are not complied with or the device is used improperly, **DINA Elektronik GmbH** accepts no liability for any resulting injury or damage.

- The product must only be installed and commissioned by a skilled electrician or a trained, instructed person, who is familiar with these operating instructions and the applicable specifications regarding occupational health and safety and accident prevention.
-



WARNING

Danger to persons and materials! In the event that specifications are not complied with, this can result in death, severe injuries or significant material damage.

Observe VDE, EN and local regulations, in particular with regard to protective measures.

- If the emergency stop is used, either the integrated restart prevention function must be used or the machine must be prevented from restarting automatically using a superordinate control system.
 - When installing the device, the required distances as per DIN EN 50274, VDE 0660514 must be taken into account.
 - During transport, storage and operation, comply with the conditions set out in EN 60068-2-1, 2-2.
 - Assemble the device in a control cabinet with at least IP54 degree of protection. Otherwise, dust and moisture can impair the functions. The device must be installed in a control cabinet.
-

- ▶ Ensure that the output contacts have sufficient protective circuitry for capacitive and inductive loads.
 - ▶ Follow the specifications in the general technical data.
-



Note

More detailed information can be found in the → **Technical data** section.



WARNING



Electric shock – dangerous voltage! During operation, switching devices conduct dangerous voltages.

Never remove protective covers from electrical switching devices during operation.

- ▶ Replace the device the first time a fault occurs.
-



- ▶ Dispose of the device in accordance with nationally applicable environmental regulations.
-

2.5.1 Retrofitting and conversion

- Unauthorized conversion voids any warranty. This can cause hazards that can lead to severe or even fatal injury.

2.5.2 Basic safety regulations

The safety regulations listed below must always be complied with. In the event that these safety regulations are not complied with or the device is used improperly, **DINA Elektronik GmbH** accepts no liability for any resulting injury or damage.

- The product described here has been developed to perform safety-related functions as part of an entire system.
- The entire system is made up of sensors, analysis units, reporting units and safe switch-off concepts.
- It is the responsibility of the manufacturer of a system or machine to validate the correct overall function.
- The manufacturer of the system is obligated to check and document the efficacy of the implemented safety concept within the entire system. This documentation must be produced again every time the safety concept or safety parameters are modified.
- The manufacturer's specifications for the system or machine with regard to maintenance intervals must be complied with.
- **DINA Elektronik GmbH** is not able to make any guarantees regarding the properties of an overall system not designed by the company.

- **DINA Elektronik GmbH** accepts no liability for any recommendations given or implied in the following description.
- No new guarantee, warranty or liability claims that go beyond **DINA Elektronik GmbH's** general delivery conditions can be derived from the following description.
- To prevent EMC disturbances, the physical environmental and operating conditions where the product is installed must correspond to the EMC section of DIN EN 602041.
- If contact outputs are used, the safety function must be requested at least once per month for Performance Level (e) and once per year for Performance Level (d).

2.6 Working on live parts



WARNING



Electric shock – dangerous voltage! Touching live components can cause severe or even fatal injury, depending on circumstances, as a result of an electric shock.

- ▶ Never assume that a circuit is dead.
 - ▶ Always check circuits as a safety precaution! Components being worked on may only be live if this is absolutely necessary and stipulated.
 - ▶ Accident prevention regulations (e.g. VBG4 and VDE 105) must be observed during all work.
 - ▶ Only use suitable, intact tools and measuring equipment.
-

3 EC declaration of conformity



Original EG-Konformitätserklärung

(gemäß der Richtlinie 2006/42/EG, Anhang II, 1A)

Original EC-Declaration of Conformity

(according to Directive 2006/42 / EC, Annex II, 1A)

DINA Elektronik GmbH
Esslinger Str. 84
72649 Wolfschlugen
Deutschland

Wir erklären, dass das folgende Produkt allen einschlägigen Bestimmungen der Richtlinie 2006/42/EG entspricht.
We declare, that the following product fulfils all the relevant provisions of Directive 2006/42 / EC.

Produkt/Product	Funktion/Function
DN3PD2 Drehzahlwächter ohne Sensorik/ sensorless speed monitoring ID-No. 34PD..	Sensorlose Drehzahlüberwachung bei Drei- und Einphasen Motoren Sensorless motion monitoring for 3-phases and single phase motors.

Weitere EU-Richtlinien/ Further EC- directives

2014/30/EU EMV-Richtlinie/EMC-Directive
2011/65/EU RoHS Richtlinie/RoHS-Directive

Benannte Stelle/Notified Body

TÜV Rheinland Industrie Service GmbH
Am Grauen Stein
D-51105 Köln

NB 0035

EG Baumusterprüfbescheinigung/EC Type-Examination certificate

Reg.-Nr./No. : 01/205/5759.00/20

Bevollmächtigter für die Zusammenstellung der technischen Unterlagen/Authorized representative for the compilation of the technical documents.

DINA Elektronik GmbH
Esslinger Str. 84
72649 Wolfschlugen
Deutschland

Wolfschlugen, 26.07.2022



Markus Henzler, Entwicklung

4 Product description

The **SAFEONE DN3PD2** is a safety switchgear for sensorless speed monitoring of electric drives.

- The readiness for operation and the switching status of the contact outputs are displayed via LEDs.
- The device has a standard USB connection. The configuration software GO:BEYOND enables a simple parameterization and online monitoring.
- The device is intended for mounting on a 35mm standard rail.

4.1 Function description

- The two-channel evaluation unit of the safety switchgear module measures the frequency of the effective rotating field of the motor at the measuring terminals U, V, W.
- After applying the operating voltage (24 V DC) to terminals A1 and A2, the safety relay will operate a self-test. The safety relay is in safe condition for the duration of the self-test. The LED OK lights up red.
- The device is ready for operation, when the LED OK lights up green.
- If the parameterized switching threshold frequencies are exceeded or undershot (f_{min} and f_{max}), or an internal or external fault exists, the enabling current paths 13/14, 23/24 open immediately. The device is in safe switching state.

4.1.1 Speed monitoring

The parameters f_{max} (maximum frequency) and f_{min} (minimum frequency) define the speed limits of the motor. The limit frequencies f_{max} and f_{min} are calculated from the speed n and the number of pole pairs:

$$f [\text{Hz}] = (n [\text{U/min}] / 60) \times \text{number of pole pairs}$$

Example: $5000 \text{ rev/min} \times 3 \text{ (number of pole pairs)} / 60 = 250\text{Hz}$

Asynchronous motors have a load-dependent slip between the motor speed and the rotating field frequency. This must be observed by the configuration of the switching threshold (f_{min} and f_{max}).



CAUTION

Note that the method of frequency measurement does not recognize a mechanically blocked motor or an overloaded motor!

The following monitoring functions are possible:

- Monitoring only at maximum speed
- Monitoring of a speed range with startup monitoring

- Monitoring of a speed range without startup monitoring

fmin: minimum frequency

If fmin is undershot, the output contacts (13-14 / 23-24) switch off.

They switch on again after the acknowledgment via the acknowledgment input Q.

Depending on the acknowledgment mode, the switch-on-conditions differ. Please note the chapter "Startup monitoring". If fmin = 0 there is no monitoring to a minimum speed. The output contacts remain closed at standstill.

fmax: maximum frequency

If fmax is exceeded, the output contacts (13-14 / 23-24) switch off.

They switch on again after the acknowledgment via the acknowledgment input Q, if fmax (minus hysteresis) is undershot.

**CAUTION**

Note that a coasting motor is detected either as a standstill (if fmin = 0, no switch-off) or underrun (if fmin > 0, switch-off).

4.2 Acknowledge function

The acknowledgment function allows the module to be reset to operational readiness after a shutdown due to under- or overspeed. The reset takes place via the input Q at the module, if none of the mentioned states is pre-sent.

Automatic or manual acknowledgment is possible. With automatic acknowledgment, the Q input must always be connected to 24V DC.

A manual acknowledgment takes place after a falling signal edge at the input Q ($t_Q \geq 200\text{ms}$ and $\leq 10\text{s}$).

4.3 Start-up monitoring

The startup monitoring time t_A is a time limit within which the actual speed must be greater than fmin. If the minimum speed is not reached during this time, the enable current path opens again.

The start-up monitoring time is parameterized (0s to 60s). It is not retriggerable, it cannot be restarted while it is running.

The start-up monitoring time starts

- In case of manual acknowledgment: with the falling edge of the acknowledge signal
- In case of automatic acknowledgment: if the actual speed is > 1Hz

In the acknowledgment mode without startup monitoring (0s), the outputs only switch on within the permitted range.

4.3.1 Functional diagram with start-up monitoring

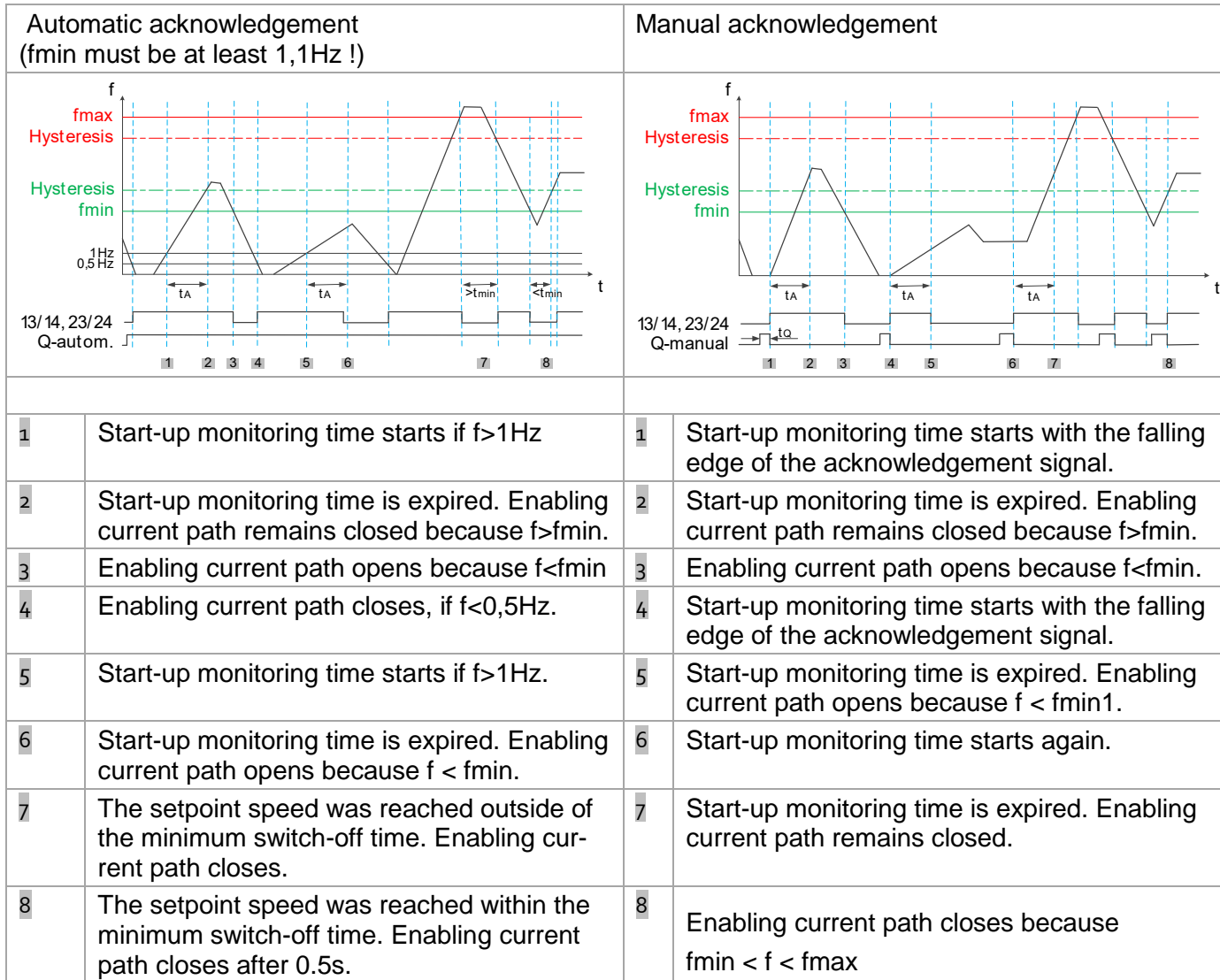

4.3.2 Functional diagram without start-up monitoring

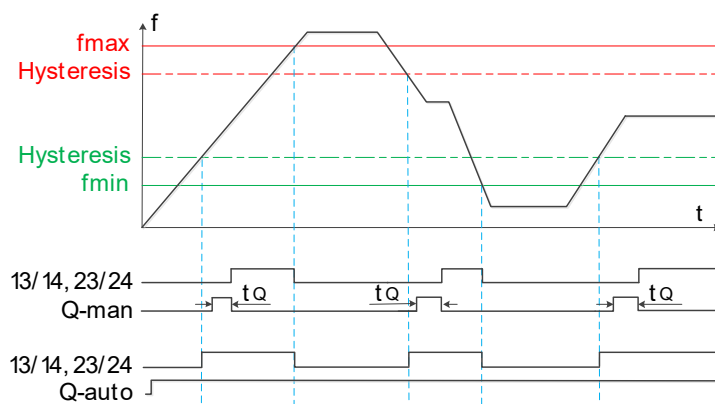

4.4 Switch-off delay

Optionally, you can set a switch-off delay t_V from 0s to 2s for the enable current path. The switch-off delay time starts if a speed limit is reached. During this time, the enable contacts remain closed and the "SPEED" LED flashes. When the switch-off delay time is expired, the enable current path opens.

If the speed reaches the target range during the switch-off delay time, the contacts remain closed and the switch-off delay time is reset.



CAUTION

Note that changing the switch-off delay affects the reaction time of the safety function!



Note

The switch-off delay time is not started when the shutdown occurs due to an internal or external fault.

4.5 Switch-on delay

Optionally, you can set a switch-on delay t_E from 0s to 10s for the enable current path. The switch-on delay time starts, if the frequency is in range and the acknowledgement is done. During this time, the enable contacts remain open and the "SPEED" LED flashes.

When the switch-on delay time is expired, the enable current path closes.

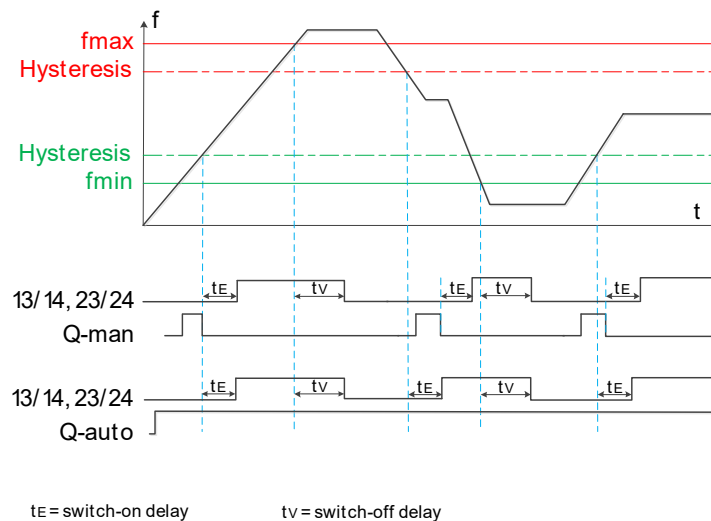

If you have also selected the "Start-up monitoring" function, the outputs only switch on after the switch-on delay time has expired. Only then is the start-up monitoring active.

4.6 Advanced settings

Application dependent disturbances (e.g., vibrations or frequency overshoots) can adversely affect the measurement process. This can lead to unintentional shutdowns. To ensure availability in the case of faulty applications, you can adjust the parameters

- Number of measuring cycles
- Measurement sensitivity

Number of measuring cycles

In the settings “measuring accuracy” you set the number of measuring cycles to detect the movement. The parameter determines with how many measurements the measured value is formed before it is switched off.

This multiple measurement has no influence on the switch-on behavior. Switching on takes place after one measuring cycle.

Default setting: 3 measuring cycles at frequencies > 30Hz

Maximum number of measuring cycles: 4



CAUTION

The set factor is multiplied by the measuring time of the system and influences the reaction time of the safety relay.

Few measuring cycles = short reaction time due to fast measuring value formation, but more prone to external disturbances

One measuring cycle = fastest reaction time

Many measuring cycles = long system reaction time but robust measurement

You can change the number of measuring cycles in the configuration software. You also define from which frequency this number should be valid.

Below this frequency, a single measurement is always used.

Sensitivity

Change these parameters only after consultation with the DINA Elektronik GmbH service.

4.7 Minimum switch-off time

The minimum switch-off time t_{min} is the time that the enable current path is at least open after triggering before it switches on again. It is 0.5s.

4.8 Password

The transfer of the parameters and the validation function can be password protected. The password can contain a maximum of 8 characters.

4.9 Validation

To validate the safety function, a validation tool is available in the configuration software.

With this function, the limit values f_{max} and f_{min} are reduced or increased by 10%, 20% or 30%, thereby forcing a switch-off.

The validation requires the entry of the device password.



Note

The validation displays the actual frequency, not the actual speed. The relation actual frequency to speed (taking into account the number of poles and the gear factor) may have to be additionally validated.

4.10 Display

The safety switchgear indicates its operational readiness and the status of the enabling current path by the two-color LEDs "OK" and "SPEED".

4.11 Diagnosis

In conjunction with the configuration software, diagnostics offers the following functions:

- Reading out values from the safety switchgear during operation
- Reading out data which are relevant for switch-off

4.12 Signal outputs

You can use the signal outputs O1 and O2 to control e.c. a non-safety PLC or signal units.

The message outputs have the following properties:

- digital
- potential-bound
- short circuit and overload protection
- not safety-related

The output O1 indicates the state of the enabling current path.

The output O2 indicates the operational readiness. This switches off in case of an error.

4.13 USB interface

Via the USB connection you connect the safety s to the PC (standard USB 2.0). You need the PC connection for the following actions:

- Transfer the configuration data
- Read out the configuration to open it in the configuration software as a project and edit it if necessary.
- Diagnosis
- Validation

4.14 Connections

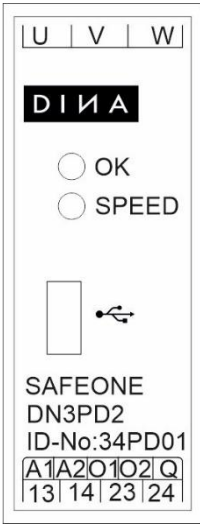
 <p>SAFEONE DN3PD2 ID-No:34PD01 A1 A2 O1 O2 Q 13 14 23 24</p>	A1	Power supply +24V DC
	A2	Power supply 0 V
	U, V, W	Measuring inputs are to be connected directly to the motor, without switching contacts between
	Q	Acknowledgment input can be parameterized, manually or automatically
	O1, O2	Digital positive switching semiconductor outputs for the transmission of switching states to a higher-level control for diagnostic tasks.
	13/14, 23/24	Enabling contacts (2 NO-contacts).
	USB Port	Mini-USB for connection at PC
	LED OK	operational readiness
	LED SPEED	state of the enabling current path

4.15 Block diagram

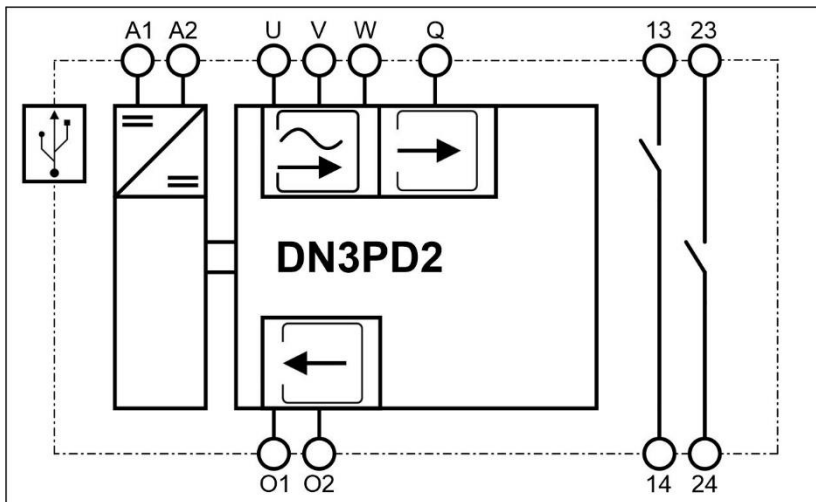

Inputs



Outputs



Measuring inputs



USB

5 Applications

5.1 Motor with frequency converter

The operation on electric power drive systems with adjustable speed is possible. (Frequency converter)



Note

Please note, that the DN3PD2 is not suitable for use on thyristor inverters.

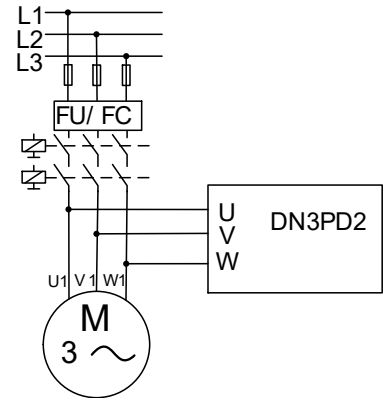

5.2 Motor with star-delta circuit

Operation on motors with star-delta connection or pole changeover is possible. For pole-changing motors, please note that DN3PD2 detects the frequency and not the speed!

The measuring inputs U and W are bridged and directly connected to W1 on the motor.

The measuring input V is directly connected to W2 on the motor.

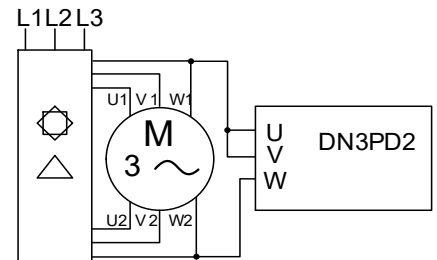

5.3 Single-phase motor

Operation on a single-phase motor is possible.

The measuring inputs U and W are bridged and directly connected to U1 on the motor.

The measuring input V is directly connected to U2 on the motor.

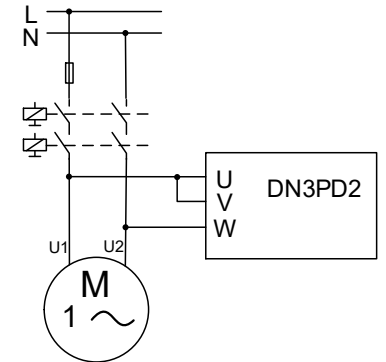

5.4 Synchronous motor



WARNING

Applications with Synchronous motors are possible to a limit extent.

The following points must be observed:

- Operation must be limited to a maximum of 480 V AC.
 - The measurement sensitivity should be set to mode 4.
 - In the measurement sensitivity modes 1 to 3 there is a risk of an undetected wire break at terminal W and a potentially dangerous detection of a standstill when the motor is running. For this reason, in applications with measuring sensitivity 1 to 3, the behavior with the motor running and wire break at terminal W should be checked.
 - At frequencies below 2.5 Hz and a wire break at terminal W, it is possible that standstill is detected.
-

6 Diagnostics and switching status displays

The safety switchgear indicates its operational readiness and the status of the enabling current path by the two-color LEDs "OK" and "SPEED". See table

The red flashing LED "OK" indicates an error.



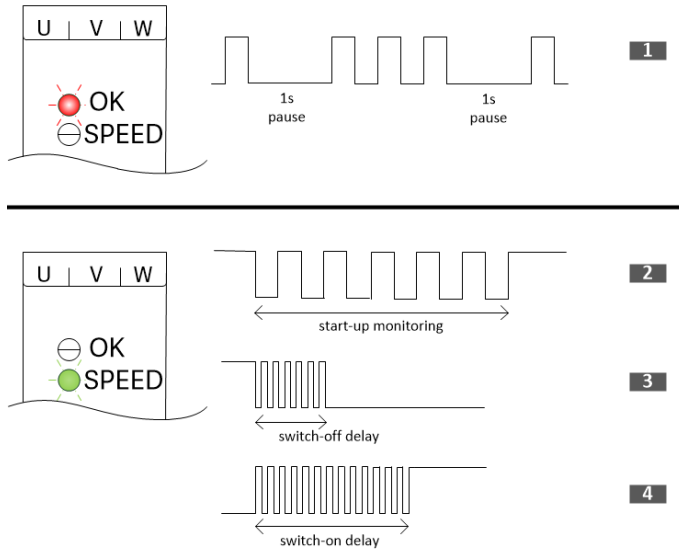



The green flashing LED "SPEED" indicates the expiry of a time constant.

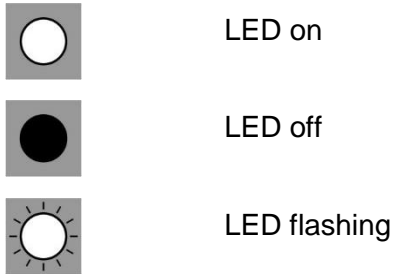











6.1 LED indicators

Legend



LED OK	LED SPEED	Flash-code	13/14, 23/24	Status	
		--	ON	acknowledged	in range
		--	OFF	not acknowledged	out of range
		2	ON	acknowledged, start-up monitoring active	out of range

		3	ON	acknowledged, off delay active	out of range
		4	OFF	acknowledged, on delay active	in range
		--	OFF	not acknowledged	in range
		1	OFF	error	See error table
		--	OFF	device defect	

6.2 Error messages

The safety switchgear shows diagnosed errors that lead to the safe state of the device, as follows:

- Flash-codes of the LED „OK“ on the device.
- Error message in the software

The blink code is repeated continuously with a pause of 1 s.

The meaning of the individual LED blink codes can be found in the table.

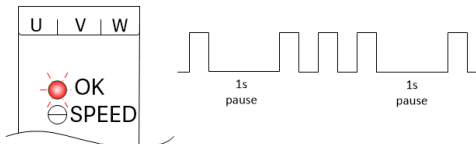

Flash-Code	Meaning / diagnostic information from the software	Remedy
1 x flash	incorrect power supply	<p>► Check power supply UB = 20.5V-26,5V DC</p>
2 x flash	transmission error parameter	<p>Check</p> <ul style="list-style-type: none"> • interface • connection cable • Have the parameters been confirmed before transfer?
3 x flash	incorrect acknowledge signal at input Q	<p>Check the wiring at input Q for cross or short circuits.</p> <p>For manual acknowledgment:</p>

		Check whether the start signal is within the time range of min. 200ms to max. 10s.
4 x flash	open-circuit on U, V, W	Check the wiring at the measuring inputs for <ul style="list-style-type: none"> • short circuit • cross-connection • wire break
5 x flash	transmission error password	The password was not confirmed. Transfer the password again.
6 x flash	Relay error	Send the device to DINA Elektronik for testing.
7 x flash	single-channel error The signals at the measuring inputs are different	Check the wiring at the measuring inputs for <ul style="list-style-type: none"> • short circuit • cross-connection • wire break
8 x flash	Frequency > 1500Hz resp. >1800Hz	Check the frequency at the measuring inputs
9 x flash	internal error	Send the device to DINA Elektronik for testing.
10 x flash	internal error	Send the device to DINA Elektronik for testing.

7 Configuration

The configuration of the DN3PD2 safety switchgear is made via the configuration software GO:BEYOND.

The parameterization of the DN3PD2 is described in the following chapters.



WARNING

Danger through incorrectly set parameters

Incorrectly set parameters for motion monitoring can lead to dangerous machine or system states.

- Make sure that the parameters entered or selected in the software correspond to the connected hardware.
- Carry out a function test after parameterization and after every change in the parameterization as part of the validation.



Note

Assistance during validation and commissioning can be a separate measuring device or the diagnostic function (display of actual and limit values) in conjunction with the validation function in the configuration software.

The diagnostic function is **not** safety-related.

7.1 System requirements

The configuration software is compatible with the following operating systems

- MS Windows 8
- MS Windows 10
- MS Windows 11

Hard disk space	min. 1 GB
Main memory	min. 2 GB
Resolution	1920 x 1080 px
Scaling	100%
Interface	USB

7.2 Installation of the Configurations-Software

The configuration software can be found in the download area of the article at dina.de/downloads/software.

Always work with the latest version of the software.

1. Installation of the software:
2. Download the software.
3. Start the installation.
4. Follow the instructions of the installation wizard.
5. Choose the language about “Settings” in the start screen.

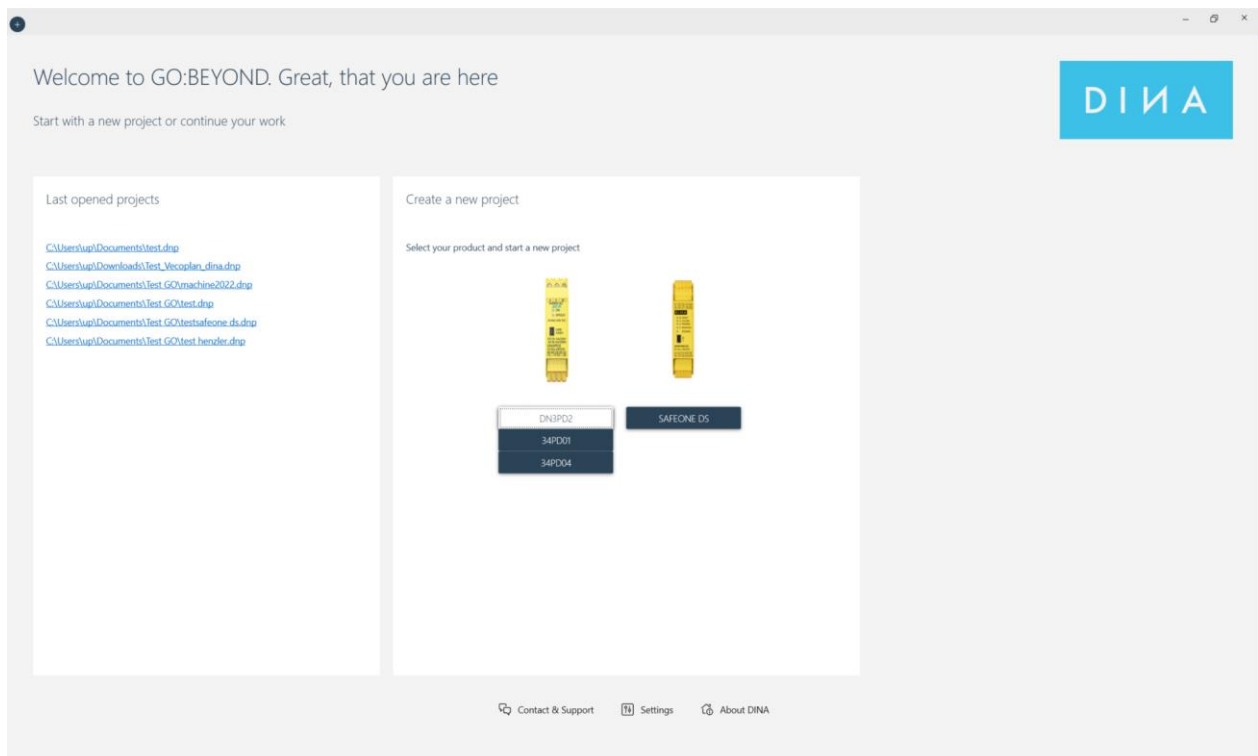

7.3 Connection to the PC

Communication between the safety switchgear and the configuration software takes place via the USB interface.

Connect the safety relay to the PC using a suitable connection cable.
The interface is suitable for standard USB cables.

7.4 User interface

The configuration software has the following user interface.

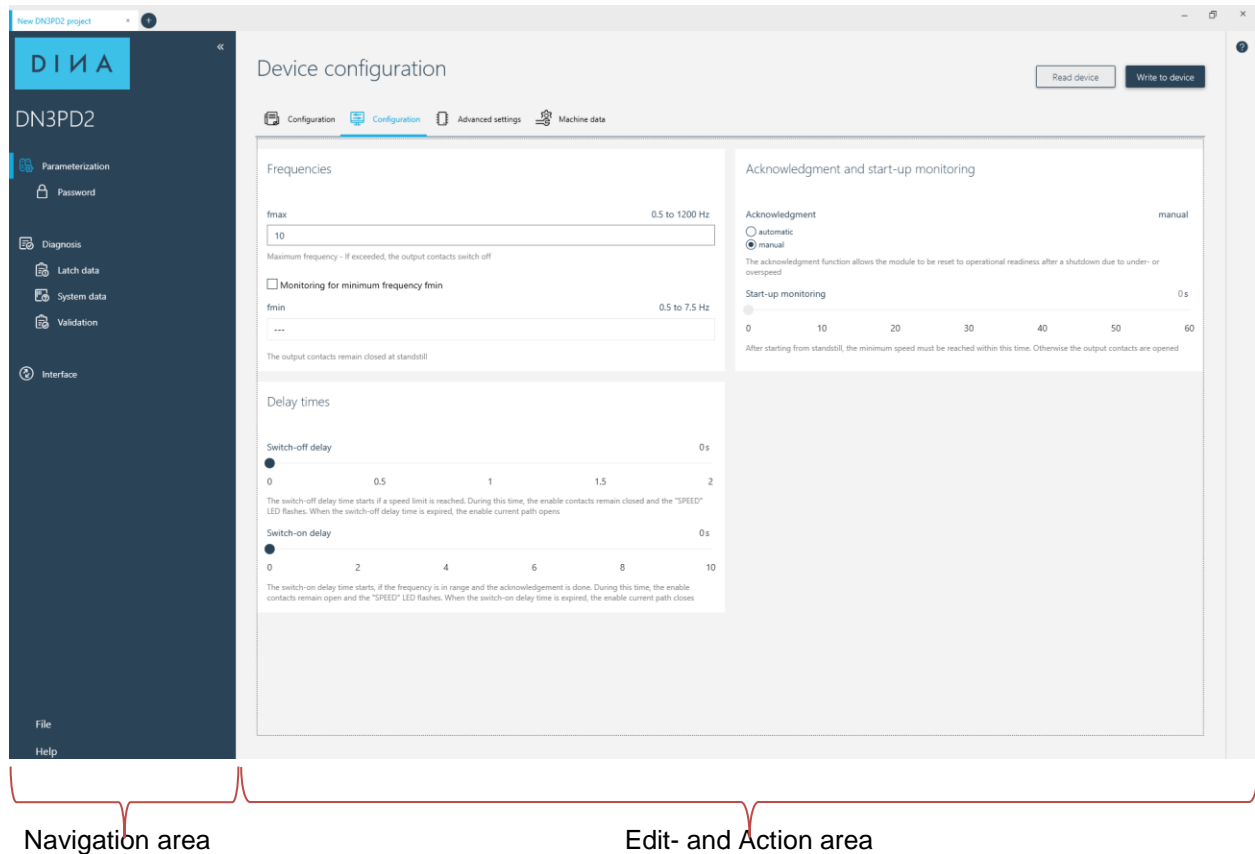

Navigation area

Edit- and Action area

Navigation area

In the navigation area you can select the following areas:

- Parameterization edit parameters, password management
- Diagnostics display of online values, error messages, switch-off-relevant data, device ID, validation
- Interface selection of the interface
- File new creation / saving / opening / printing / closing a project
- Settings display of the working directory
- Help help-menu

Edit- and Action area

This area offers the following functions:

- Edit parameters

- Read out the parameter from the switch gear to the configuration-software
- Transmit the parameter from the configuration-software to the switch gear
- Help

7.5 Parameterization

You can make the following settings on the configuration software

Parameter	Range	Note
COM-Port		
Password	maximum 8 signs	
fmax *)	0.5 - 1200 Hz or 100 Hz – 1650 Hz	At ID-Nr. 34PD03: >30Hz – 1200Hz
fmin *)	>0.5 Hz deselectable	At ID-Nr. 34PD03: >30Hz – 1200Hz
Acknowledgment	- manual - automatic	Automatic acknowledgment with start-up monitoring: fmin ≥ 1.1 Hz
Start-up monitoring	0-60s	0 ≙ only range-monitoring
Switch-off delay	0-2s	
Switch-on delay	0-10s	
Project name	maximum 8 signs	absolutely necessary
Author		Is not transferred to the device.
Date	mm.dd.yy	
Advanced settings		
Frequency threshold	16 steps	
Number of measuring cycles	1-4	
sensitivity	Modus 1-4	
Machine data		
Axis type	Linear axis, spindle, rotary axis	
Number of pole pairs	1-99	
Ratio	0.01-99999	
Radius	1-9999	
Pitch	0.001-9999	
Minimum speed		Depending on the machine data and the permitted maximum frequency.
Maximum speed		

*)

- To determine the switching thresholds, the number of pole pairs must be taken into account: $f \text{ [Hz]} = (n \text{ [U/min]} / 60) \times \text{number of pole pairs}$
Example: $5000 \text{ rev/min} \times 3 \text{ (number of pole pairs)} / 60 = 250\text{Hz}$

- Asynchronous motors have a load-dependent slip between the motor speed and the rotating field frequency. This must be taken into account when parameterizing the threshold frequencies (fmin and fmax).

7.6 Machine data

The "Machine data" calculation tool can be used to determine fmin and fmax.

Enter the machine-specific data and the tool calculates the associated frequencies. The machine data can be saved in the device. Check the checkbox "Take over machine data". Then it is no longer possible to enter the frequencies directly in the "Parameterization" menu.

7.7 Read out the project

You can read out the parameterization saved on the safety relay.

No password is required for reading out.

- ▶ Start the configuration software.
- ▶ Select the device.
- ▶ Open the "Interface" menu item and select the COM port.
- ▶ Open the "Parameterization" menu item.
- ▶ Click the "Read out device" button.

7.8 Create a project

- ▶ Start the configuration software.
- ▶ Select the device.
- ▶ Open the "Interface" menu item and select the COM port.
- ▶ Open the "Parameterization" menu item.
- ▶ Edit the parameter.
- ▶ Transmit the project to the device with the button „save on device“.
- ▶ There is always a password prompt. If no password is saved, confirm the query with "ok".
- ▶ Verify the correct parameters and confirm the settings.
- ◀ The data is transferred to the device.
- ▶ Save the project.

7.9 Edit and Change password

Protect your safety relay against unauthorized access with a device password.

- ▶ Open the menu item "Parameterization password"
- ▶ Enter the current password. If no password is assigned, the field can remain empty.

- ▶ Edit a new password and confirm it.
- ▶ Click the button “Write to device”.

The password is now stored in the device and must be specified when transferring a new project or when validation.

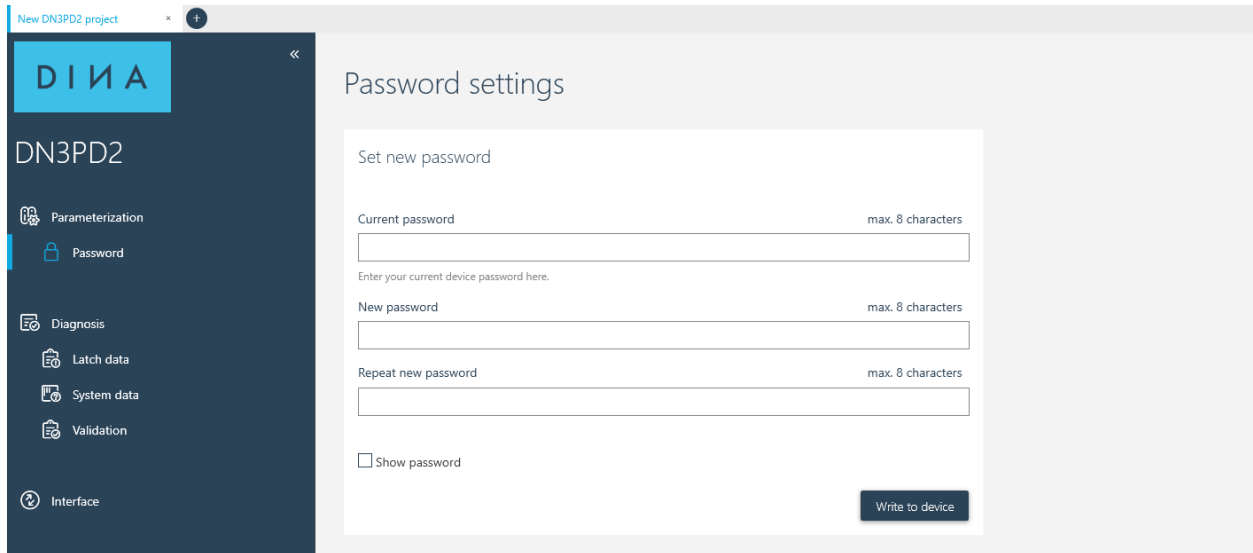

7.10 Diagnose

Die Diagnose bietet folgende Funktionen:

1	Diagnosis start / stop	Start or stop the diagnosis
2	Movement/time diagram	For visual representation of the movement: blue line: actual frequency red lines: fmin and fmax
2a	Unit switching	Representation of the actual and limit values in Hz or corresponding speed unit.
3	Status display of the input and output	13/14, 23/24: Status of the enabling current path O1: Status the output O1 O2: Status the output O2 Q: Status of the input Q
4	Help and error list	Help texts and occurred errors
5	Latch Data	Read out switch-off relevant data <ul style="list-style-type: none"> - Actual frequency - States of the outputs/input - advanced mode for service
6	Device ID	Hardware and Firmware information
	Validation	See chapter „Validation“

Diagnosis

Actual value

R/min

Start

2a

Hz R/min

Actual value: 41.06 R/min Limit Min: 19.80 R/min Max: 79.20 R/min

Status of inputs/outputs

13/14
23/24
O1
O2
Q

Description

The diagnosis shows the current status of the device

connected (COM7)

Latch data

Read device

Description

After a shutdown, the switch-off-relevant data is saved in the device and can be read out. The data remains saved until it is switched off again

Measurement

Actual value Master

19.84 R/min

65.33 Hz

Actual frequency measured at the switch-off

Actual value Slave

19.84 R/min

65.46 Hz

Actual frequency measured at the switch-off

Limits

Max. speed

80 R/min

264 Hz

Min. speed

20 R/min

66 Hz

States

Advanced view

O1

O2

Relay (13/14, 23/24)

Acknowledgement

System data

Read device

Project data Device data

Project information

Project name

Machine1

Date of the application

4/19/2022

Checksum

Checksum

A862

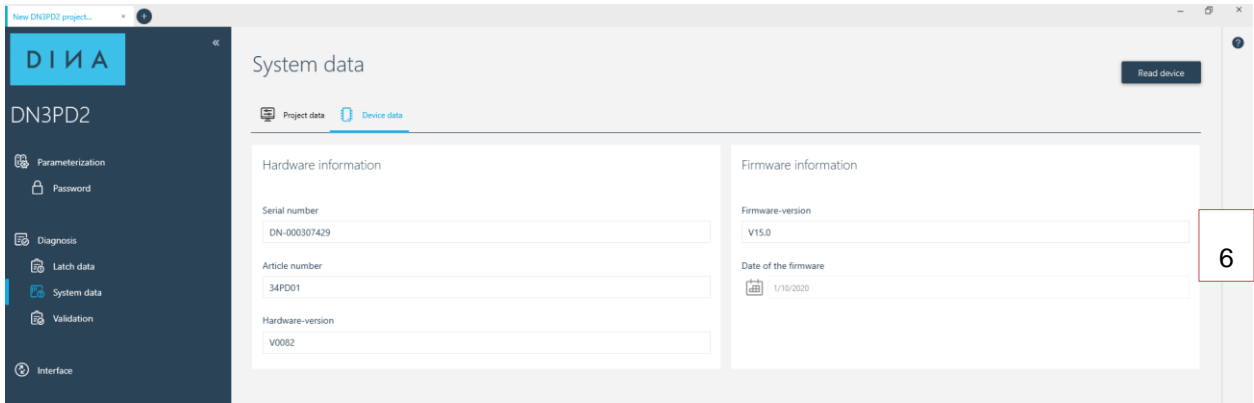

7.11 Validation

- ▶ Select the validation step
- ▶ If the device is password-protected, you will be asked to enter a valid password.

The states are recorded and can be printed out as a protocol.
The validation level is automatically reset after 10s.

- ▶ Press the “Stop” button to stop recording



Alternatively, you can use the “auto. Start “. The validation levels are run through step by step and reset again. The automatic validation stops automatically

DIANA

DN3PD2

- Parameterization
- Password
- Diagnosis
 - Latch data
 - System data
 - Validation
- Interface

File Help

Validation

Start

Set validation levels manually

0 % 10 % 20 % 30 %

Select the validation level.

Automatic validation

auto Start

With automatic validation, all validation levels are run through and recorded.

Description

With this function the limit values fmax and fmin are reduced or increased by 10%, 20% or 30% and forced to switch off. The validation requires the input of the device password

Diagnosis

Actual value

Hz R/min

300.00
250.00
200.00
150.00
100.00
50.00

15:04:44 15:04:48 15:04:52 15:04:56 15:05:00 15:05:04 15:05:08 15:05:12

Actual value: 212.30 Hz Limit Min: 66.00 Hz Max: 264.00 Hz Validation step: 0 %

Status of inputs/outputs

13/14
23/24
O1
O2
Q

© connected (COM7)

8 Example of application

Speed monitoring of a 3-phase motor

- Release of output contacts 13/14, 23/24 if adhered to
 - the minimum frequency to be monitored
 - the maximum frequency to be monitored
- Manually monitored start
- Monitoring of external positively guided contactors K1/K2



Note

Make sure that the measurement inputs U, V, W are permanently connected to the motor windings.

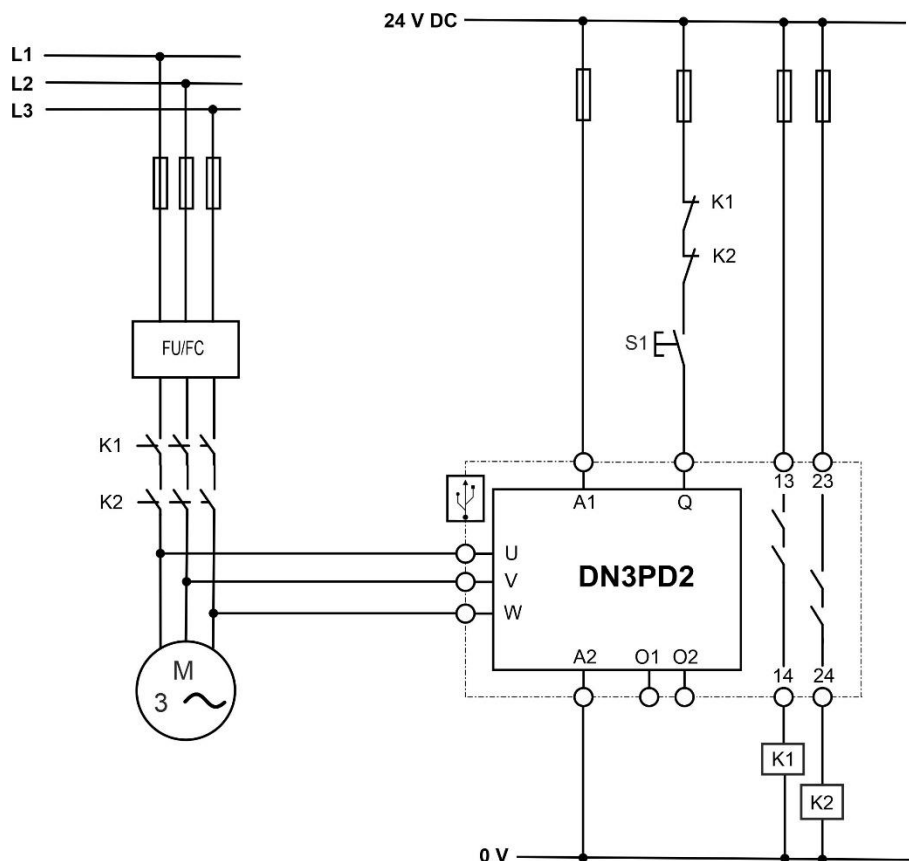

Legend:

S1	manual acknowledgment facility
K1/K2	positively guided contactors
FU/FC	frequency converter
M	motor

9 Order information

Description	Product	ID-No.
Speed monitoring, sensorless 0-1200 Hz, 2 contact outputs, USB interface	DN3PD2	34PD01
Speed monitoring, sensorless 0-1200 Hz, 2 contact outputs, USB interface, coast detection	DN3PD2	34PD02
Speed monitoring, sensorless >30 Hz-1200 Hz, 2 contact outputs, USB interface	DN3PD2	34PD03
Sensorlose Drehzahlüberwachung 100 Hz -1650 Hz, 2 contact outputs, USB interface	DN3PD2	34PD04

10 Technical data

10.1 Supply

Operating voltage U_B	24 V DC (-15/+10%)
Current consumption at 24V	< 80 mA
Power consumption at A1/A2	1,9 W

10.2 Digital inputs

Inputs	Q
Input voltage range	24 V DC (-15/+10%)
Current consumption	typ. 4 mA (at U_B)

10.3 Measuring inputs

Inputs	U, V, W
Input voltage range	90V to 690V AC
Current consumption	0,35mA at 690V AC

Limit frequency	34PD01, 34PD02	34PD03	34PD04
fmin	0,5 Hz	31 Hz	100 Hz
fmax	1200 Hz	1200 Hz	1650 Hz
Minimum-PWM	2kHz		
Measurement uncertainty	1%		
Switching hysteresis	10%		

10.4 Signal outputs

Outputs	O1, O2 Non safety
Voltage range	UB-1V
Switching current	≤ 100mA shot-circuit and overload protection

10.5 Contact outputs

Outputs	13/14, 23/24
Contact material	AgSnO ₂
Output guidance	
Minimum switching current	10 mA
Maximum switching current	6 A
Switching capacity in accordance with IEC 60947-5-1	DC13: 4A/24V AC15: 5A/230V
Mechanical service life	10 ⁷ switching cycles
Electrical life	10000 cycles (EN 61810-1, 6A 250 V AC, cos φ =1, 80°C) 10000 cycles (EN 61810-1, 6A 24V DC, resistiv, 80°C) 6000 cycles (UL508, B300, 80°C)

	6000 cycles (UL508, R300, 80°C)
Contact fuse	6 A gL/gG
Typical response time	Number of measuring cycles x (period (<i>reciprocal value of the set frequency</i>) + max. 2ms cycle time) + max 10ms relay switch-on time

10.6 General data

Type of protection (housing and terminals)	IP 20
Type of protection (place of installation)	min. IP 54
Clearance and creepage distances between circuits	In accordance with DIN EN 50178
Rated insulation voltage	400V AC
Rated surge voltage/insulation	Basic insulation 6kV: between all current paths and housing Safe insulation, reinforced insulation 8kV: between U, V, W and USB interface between U, V, W and A1, A2, O1, O2, Q between U, V, W and 13/14, 23/24
Degree of contamination	2
Overtoltage category	III
Housing material	Polyamide (PA), not reinforced

10.7 Connection data

Terminals	Push-in, pluggable		Screw, pluggable
	4	5	
Number of positions	4	5	3
Conductor cross section	0,25 – 2,5mm ²	0,25 – 1,5mm ²	0,25 - 2,5mm ²
AWG conductor cross section	24...12	24...16	24...12
Min/max tightening torque	-	-	0,5Nm/0,6Nm

Conductor type	Flexible with end sleeves
Stripping length	8 mm

10.8 Environmental conditions

Operating temperature	-20 °C to +55 °C
Storage temperature	-40 °C to +85 °C
Attitude of place of use	< 2000 m above sea level
Shock resistance	15g

10.9 Dimensions

B x H x T	22,5 x 114 x 111 mm (0.886 x 4.488 x 4.370 in)
Size of DIN rail	35,0 mm (1.378 in)
Weight	130g

10.10 Safety technical data

Stop category in accordance with IEC 60204	0
--------------------------------------------	---

10.11 Safety-related parameters in accordance with DIN EN ISO 13849-1:2016-06

Category	4
Performance Level	e
MTTFd [a]	171 (1A DC13; 2 cycles/h) 114 (3A AC15; 2 cycles/h)

For PLe the safety function must be requested at least once per month.

10.12 Safety-related parameters in accordance with EN ISO 61508- High Demand

HFT	1
-----	---

SIL	3
PFHd [h]	5,52 x 10 ⁻⁹ (1A DC13; 2 cycles/h) 5,86 x 10 ⁻⁹ (3A AC15; 2 cycles/h)
Demand rate	< 12 Monate
Proof-Test-Intervall	240 Monate

11 Installation and removal

11.1 Installing a module

11.1.1 Overview

- (A) 70-75 mm (2,756-2,953 in)
- (1) Top hat rail
- (2) Locking slider
- (3) Cable duct

Procedure

- ▶ Hook the module onto the top hat rail (1) and press it downward.
- ▶ The locking slider (2) engages under the top hat rail.

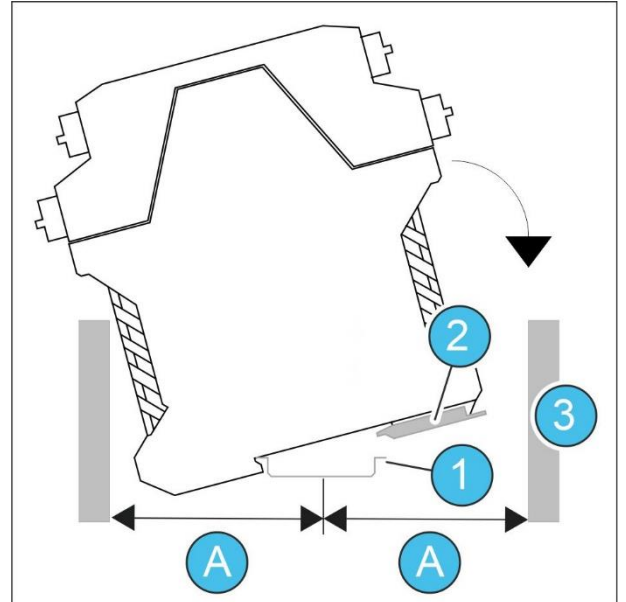

11.2 Removing a module

Procedure

- ▶ Use a screwdriver (1) to move the locking slider away from the module.
- ▶ Move the module upward and remove it from the rail.

